



**ROTH SUGAR BUSH
MAPLE EQUIPMENT**

www.rothsugarbush.com

CDL WISCONSIN

ROTH SUGAR BUSH

2019 Catalog & Price List

Proud to be CDL's Largest Retailer in the U.S.

715-289-3820

info@rothsugarbush.com



New Expanded Facility



Original Facility



**ROTH SUGAR BUSH
MAPLE EQUIPMENT**

CDL WISCONSIN

Roth Sugar Bush, Inc Maple Equipment and Syrup

656 Tower Drive Cadott, WI 54727
(715) 289-3820 Fax: (715) 289-3821



**ROTH SUGAR BUSH
MAPLE EQUIPMENT**

Hello Fellow Maple Sugaring Friends

Don't the years seem to fly by...here we are again approaching the 2019 Maple Sugaring Season with enthusiastic anticipation! We know that everyone has a very busy schedule these days so we are here to make your shopping experience quick and easy. You can order conveniently on our secure Website or you can give us a call and order with one of our friendly representatives. If you are looking for something special that we don't carry, we will do our very best to help you find it.

Here at CDL Wisconsin, Roth Sugar Bush every producer is important to us. We are here for the beginner to help them get started as well as the backyard hobbyist to the very largest producers'. We have everything you need in your maple sugaring operation. We are also here to answer all of your questions and we have some great "How To" videos on our Website that provide great information for everyone.

We pride ourselves on offering only the finest quality maple sugaring equipment and we provide exceptional service with every sale.

We are here to proudly serve you at our Cadott location or you can stop in and see one of our Sub-Dealers in surrounding areas who are also happy to help you with whatever you are looking for;

Jim Adamski, Antigo, WI. 715-216-7855
Tim & Amber Woodrow, Aitkin, MN. 218-429-5805
Russ Schneveis, Athens, WI. 715-257-7713
Emanuel & Owen Hershberger, Cashton, WI.

John & Crystal Morley, Luck, WI. 715-554-2301
Don Hanson, Taylors Falls, MN. 612-201-1086
Roger & Tony Bundy, Eau Galle, WI. 715-495-0872
Steve Horner, Boyceville, WI. 715-643-3711

Our highly skilled service department spends many hours in the CDL Corporate Manufacturing Facility in Canada for hands on advanced training so we can better serve you with any problem you encounter. Please don't hesitate to give our expert line a call with any questions you may have.

We again look forward to seeing you all at our open house this year, which is looking to be bigger and better than ever. This year's dates are: Wednesday, February 6th, Thursday, February 7th, Friday, February 8th & Saturday, February 9th. Open House hours are 8:00 am to 4:00 pm daily. We will have complimentary coffee & donuts in the morning and a home cooked complimentary lunch will be served each day at Noon. Our Open House is always a great time to stock up on your Sugaring Supplies as we will again be offering a 5% cash and carry discount. Please call ahead with your order so we can have it ready when you come to our Open House. Watch our Website & our Facebook page for seminars & guest speakers during our open house.

We sincerely thank you for your continued business!

Peter & Dawn Roth

**Come to our Annual Open House
at our Superstore in Cadott, WI
February 6th, 7th, 8th & 9th, 2019**

Please visit our website and sign up for our Email Newsletter.



A WORD OF WELCOME

In 2019, labor shortages will likely be our biggest challenge. Innovation will be the key to facing this major, long-lasting issue while continuing to improve the maple syrup we produce.

At CDL, we believe that automation, powerful equipment and a remote monitoring system are part of the long-term solution for all maple sugar producers. This idea is the foundation of our 4.0 system.

Maple sugaring needs to be appealing to youth so that we can draw them to our incredible sector. Young workers are the best way to advance and evolve our industry so it can reach its fullest potential. There are a number of opportunities on the horizon.

Innovative products will soon be added to complement maple syrup. They will add a whole new dimension to maple sugaring and present even greater opportunities. That's why it's important to be prepared.

The CDL family wants to thank you for trusting us for so many years. We wish you an excellent 2019 season.

See you soon!

On behalf of everyone at CDL,

Martin Chabot, co-owner



TURNKEY PROJECTS WITH CDL



Pipe and tubing installation

We provide tips for installing pipes and tubing and refer you to direct and trusted resources for your project.



On-site service

Repairs for all brands: welding, electrical problems, plumbing, starting equipment and burner adjustments.



Turnkey equipment installation

Delivery and complete installation of your maple sugaring equipment by CDL experts and technicians.



GPS mapping

Positioning and strategic planning of equipment, pumping stations, mainlines and much more.



Technical service

Mainline sizing, pump line sizing and flow calculations are things that we calculate every day.



Project evaluation

Have your project evaluated fully and directly by the largest supplier of sugarbush equipment.

TABLE OF CONTENTS

Don't miss

16 SpinSeal

Pre-lashed mainlines **19**

30 Autonomous sugarbush

CDL Monitoring **31**

43 Self-cleaning extractors

Isolated calibration tank **54**

60 Intelligent RO

Master™ evaporators **71**

77 Draw-off valves

Self-cleaning filter press **85**



The hobby zone **4**

3/16" fittings and tubing, spouts, MAXFLOW fittings, fittings for tubing **9**

SpinSeal™ SpinSeal **16**
TECHNOLOGY

Tubing and mainlines, electrofusion fittings **17**

Wire and accessories, tools **22**



CDL monitoring **31**

Stainless steel fittings, fittings, valves and plumbing **34**

Extractors, moisture traps and vacuum booster tanks **43**

Vacuum pumps and accessories, gauges and pressure pumps **48**

Stainless steel tanks, tanks and accessories **52**

Reverse Osmosis **57**



Evaporators and accessories **66**

Measuring instruments **81**

Cleaning accessories **83**

Filter presses and accessories **84**

Barrels, accessories and processing equipment **88**

Jugs, cans and accessories, bottles and packaging **92**

Books **108**

Corporate stores, sales representatives and dealers **109**

THE HOBBY ZONE

INSTALLATION WITH 3/16" GRAVITY TUBING

All 3/16" fittings,
spouts and tubing
see page 12.



A GOOD SUGARING SEASON STARTS WITH CDL!

Whether you're tapping 50 trees with buckets or 1,000 with tubing, CDL has what you need!



CDL VACUUM FILTER PRESS

SYRUP FILTER TANK AND FILTER PRESS

AVAILABLE IN 9", 12", 15" AND 18" SIZES.



9" CDL vacuum filter press	3.6 US gal.	FAU18PV009
12" CDL vacuum filter press	9 US gal.	FAU18PV012
15" CDL vacuum filter press	14 US gal.	FAU18PV015
18" CDL vacuum filter press	19 US gal.	FAU18PV018
Vacuum filter press polyester filter	9"	FAU18036
	12"	FAU18038
	15"	FAU18017
	18"	FAU18018
	21"	668171
Vacuum filter press polyester prefilter (12/pkg)	24"	668172
	9"	FAU18035
	12"	FAU18037
	15"	668167
	18"	668168
	21"	668169
	24"	668170

VIDEO AVAILABLE ON



**REDUCE BOILING TIME UP TO 50%
WITH CDL HOBBY RO FOR SMALL PRODUCERS**

THE HOBBY ZONE

HOBBY RO (100 GPH - 200 GPH - 300 GPH CAPACITY)



**WASHING
TANK OPTION**
OSH0-A00007



IDEAL FOR 500 TO 2000 TAPS

- Cost-effective and ultra-compact
- Made mostly of stainless steel components
- All pumps are entirely made of stainless steel
- Electrical consumption
120 volts (17 amp.), 240 volts (10 amp)
- Offers low pressure and high temperature protection
- Wheel system allows easy movement without effort
- Easy to operate
- No need to store in a heated room if properly drained



100 GPH HOBBY RO

81050

Ultra-compact model
CDL quality product
Easy to use and easy storage
Ideal for up to 500 taps

VERTICAL HOBBY RO

Available in 125 and 250 GPH model
Unbeatable price / performance ratio
CDL quality product
Easy to use and easy storage
Ideal for up to 2,000 taps

HORIZONTAL HOBBY RO

Available in 125, 250 and 300 GPH model
Useful horizontal design
CDL quality product
Easy to use and easy storage
Ideal for up to 2,000 taps

**MONITORING
STARTER KIT FOR
SMALL PRODUCERS**

21090-EN

KIT INCLUDES:

- 5 SINGLE VACUUM SENSORS
- 1 GATEWAY
- 1 CONTROLLER (MINI-PC)
- 1 HD MONITORING SCREEN
- 1 WIRELESS MOUSE + KEYBOARD

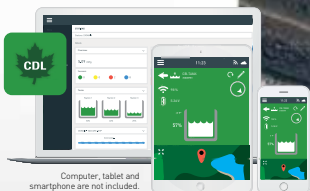

Computer, tablet and smartphone are not included.



TAKE CONTROL OF YOUR SUGARBUSH AND HAVE ACCESS TO YOUR DATA EVERYWHERE AND IN REAL TIME WITH CDL.



5

The CDL way. The power of expertise. / 2019 catalog / cdltusa.com

THE HOBBY ZONE

CHOOSE CDL QUALITY FOR
BOILING YOUR MAPLE SYRUP!

CDL CLASSIC EVAPORATOR ONE PAN MODEL

IDEAL FOR 50 TO 100 TAPS

69FBEATK1



\$1270.00

- 2' x 4' evaporator arch
- 2' x 4' boiling pan
- 3/4" draw-off ball valve
- 8' of 7" galvanized stack

- Can be used outdoors
- Evaporation of 10 GPH
(can make 1 gal. of syrup every 4 hours)
- Overall dimension 26" x 65" x 31" high
- Weight: 257 lb without bricks;
778 lb with bricks;

Not included: cement, bricks and dial thermometer

1" AUTOMATIC DRAW-OFF VALVE

\$640.00 66786



The new cost-effective CDL 1" automatic draw-off valve allows you to get precise maple syrup flow from your evaporator, every time!



BEGINNER BOILING KIT



16" x 16" kit PRFW16 \$495.00

INCLUDES:

- 1 R-65 propane burner
- 1 hose and regulator
- 1 16" x 16" sugar pan
- 1 propane burner support
- 1 3/4" stainless steel nipple
- 1 3/4" FIPT stainless steel ball valve



16" x 32" kit PRFW32 \$699.00

INCLUDES:

- 2 R-65 propane burners
(with fastening kit)
- 2 hoses and regulators
- 1 16" x 32" sugar pan
- 1 16" x 32" propane burner support
- 1 3/4" stainless steel nipple
- 1 3/4" FIPT stainless steel ball valve



16" x 16" 15 tap kit 6600801 \$575.00

INCLUDES:

- 1 16" x 16" sugar pan cover
- 1 16" x 16" sugar pan
- 1 R-65 propane burner
- 1 18.5" wooden handle thermometer
- 1 Orlon filter #8 thick
- 1 55-70 Brix syrup hydrometer
- 1 8" cup
- 1 3/4" stainless steel nipple
- 1 3/4" FIPT stainless steel ball valve

Evap-O-Grill

THE HOBBY ZONE



THE 2-IN-1 CDL EVAP-O-GRILL

IDEAL FOR UP TO 50 TAPS
EVAPORATES UP TO 7 GPH

670090 **\$995.00**

INCLUDES:

- 2' x 3' Stainless steel pan
- 3/4" SS ball valve
- Evap-O-Grill BBQ grates
- Cast-iron-arch
- Cast iron fire grates
- Not included: 6" standard smokestack with damper

NO BRICKING NEEDED

Option: sap preheater
Ideal for preheating sap



Evap-O-Grill sap preheater	670096	\$150.00
Evap-O-Grill BBQ grate kit	670095	\$52.95

SYRUP FILTER TANK

5.85 US gallons
9" diameter



67MINFIL \$280.00

INCLUDES:

- 1 SS lid
- SS drain valve

Other sizes
on page 79

BEGINNER BOTTLING KIT

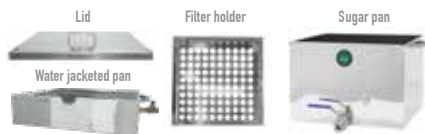

Beginner bottling kit 6600802 \$990.00

INCLUDES:

- 1 16" x 16" sugar pan cover
- 1 16" x 16" sugar pan
- 1 16" x 16" filter holder
- 1 R-65 propane burner
- 1 1/2" FIPT stainless steel ball valve
- 1 16" x 16" water jacketed tank
- 1 propane burner support
- 1 3/4" stainless steel nipple
- 1 1/2" stainless steel nipple
- 1 3/4" FIPT stainless steel ball valve



With adjustable shelf

DIAPHRAGM PUMPS

IDEAL FOR UP TO 700 TAPS



See page 48

THE HOBBY ZONE

BUCKET SPOUTS



5/16" bucket spout
660551

\$1.05



7/16" Spout without hook
Aluminum
660557

\$1.60



7/16" white bucket spout
66055000A1

\$0.90



5/16" Spout without hook
Aluminum
660555

\$1.60



7/16" bucket spout
Stainless steel
660555

\$1.55

COVERS AND ACCESSORIES



Galvanized cover for 2-gallon
bucket
66660

\$2.75



2-gallon grey plastic
bucket
663054

\$3.90



Green plastic cover for 2-gallon
bucket
663056

\$3.25



2-gallon green plastic
bucket
663052

\$3.90



Green plastic cover
for 3-gallon bucket
663057

\$3.25



2-gallon blue plastic
bucket
663050

\$3.90



Blue plastic cover for 3-gallon
bucket
663055

\$3.25



3-gallon green plastic
bucket
663051

\$5.00



Wire for galvanized cover
(25/Pkg)
LIDWIR

\$6.10



2-gallon blue plastic
bucket
663050

\$3.90

Galvanized bag holder
69BUCKET0102

\$2.85

3-gallon blue plastic
bucket
663053

\$5.00

Blue sap bag
663032

\$0.29

TAPPING STARTER KIT 15 TAPS



Includes:

- 1 short tapping bit 5/16"
- 15 bucket spouts 5/16"
- 15 plastic buckets (2 gallon)
- 15 galvanized bucket covers
- 1 CDL aluminum tapping hammer
- 1 aluminum spout remover (15")

6600800

\$180.00

Signature SPOUTS

CDL along with customers have worked hard over the years to create the best spouts available in the industry.

We think CDL Signature Spouts are the perfect choice for your sugarbush. Here's why:

MINIMUM RESTRICTION

The 45° angle facilitates sap flow and prevents residue or unwanted bacteria from accumulating.

NEW

Our new signature spouts are made with a UV coating and come with 2 Maxflow barbs for a better grip on tubing.

NEW

PERFECT SEAL

The thin wall works with the perfect taper to create a completely airtight seal.

LONGER SPOUT WORKS BETTER ON THICK BARK.

DID YOU KNOW?

It's been proven that a smaller tap hole doesn't affect the volume of sap collected under vacuum. Keep your maple trees healthy over the years.

Spouts available in 5/16" and 1/4" sizes and many colors for better tapping control in the woods.

3/16" FITTINGS AND TUBING

3/16" gravity tubing

Ideal for sugarbushes without electricity and maple producers who do not want to use a mechanical system for vacuum.

- > Increases production
- > Creates a vacuum without a pump
- > Better sap quality than standard gravity system
- > As simple as using buckets, but with less work and better performance





3/16" CDL SEMI-RIGID TUBING

WARRANTY	COLOR	PRODUCT CODE	LENGTH
8 year	BLUE	431610021	500'
8 year	BLUE	431608221	1 000'
8 year	GREEN	431608025	500'
8 year	GREEN	431608225	1 000'

MAXSEAL MULTI-FITTINGS / FIXED HEAD

Screw kit not included

	3/4"	66096395	\$2.20
	1"	66097395	\$2.35
	Maxseal single gasket	66091C	\$0.25
	Screw Kit	66099099	\$0.28

3/16" FITTINGS

	3/16" clear <i>Signature</i> spout 66045316	\$0.20
<small>We recommend the use of a 5/16" drill bit for tapping</small>		
	3/16" white spout with barbs MAXFLOW 66090316	\$0.25
<small>We recommend the use of a 19/64" drill bit for tapping</small>		
	3/16" clear spout with barbs MAXFLOW 66090358	\$0.25
<small>We recommend the use of a 19/64" drill bit for tapping</small>		
	3/16" end of line hook 66279357	\$0.20
	3/16" flat hook connector 66303357	\$0.21
	5/16" - 3/16" flat hook connector 66303356	\$0.21
	3/16" T with pin 66030360	\$0.30
	3/16" end of line T with pin 66030361	\$0.34
	3/16" - 3/16" - 5/16" health T drop line 66030355	\$0.30
	3/16" health T 66030357	\$0.30
	3/16" health T end of line 66030358	\$0.34
	5-16" - 5/16" - 3/16" health T drop line 66030356	\$0.30
	5-16" - 5/16" - 3/16" health T end of line 66030359	\$0.34

Keep track of your tapping crew's performance by using different color spouts for each employee.

SPOUTS

BARB *Signature* SPOUTS



Blue thin wall Signature spout with barbs	5/16"	66045263	\$0.21
	1/4"	66045324	\$0.21



Clear thin wall Signature spout with barbs	5/16"	66045264	\$0.21
	1/4"	66045024	\$0.21

Signature SPOUTS



Blue thin wall Signature spout	5/16"	66045063	\$0.21
	1/4"	66045314	\$0.21



Clear thin wall Signature spout	5/16"	66045064	\$0.20
	1/4"	66045014	\$0.20



Green thin wall Signature spout	5/16"	66045067	\$0.21
	1/4"	66045714	\$0.21



Light blue thin wall Signature spout	5/16"	66045068	\$0.21
	1/4"	66045814	\$0.21



Smoke thin wall Signature spout	5/16"	66045069	\$0.21
	1/4"	66045114	\$0.21



Red thin wall Signature spout	5/16"	66045065	\$0.21
	1/4"	66045514	\$0.21



Pink thin wall Signature spout	5/16"	66045066	\$0.21
	1/4"	66045614	\$0.21

We recommend the use of the 5/16" drill bit for tapping with 5/16" Signature Spout.
We recommend the use of the 1/4" drill bit for tapping with 1/4" Signature Spout.

30° DURABLE SPOUTS



30° 5/16" black spout with barbs	\$0.25
66090039	
<small>We recommend the use of the 5/16" drill bit for tapping.</small>	



30° 5/16" natural spout without barbs	\$0.25
66090042	
<small>We recommend the use of the 5/16" drill bit for tapping.</small>	



30° 5/16" natural spout with barbs	\$0.25
66090040	
<small>We recommend the use of the 5/16" drill bit for tapping.</small>	



30° 17/64" smoke spout with barbs	\$0.21
66090019	
<small>We recommend the use of the 1/4" drill bit for tapping.</small>	



30° 17/64" blue spout with barbs	\$0.25
66090038	
<small>We recommend the use of the 1/4" drill bit for tapping.</small>	

7/16" SPOUT



7/16" spout	\$0.35
6605309902	

STUBBY SPOUT FOR ADAPTOR



Stubby spout black	\$0.28
66090053	

30° DISPOSABLE SPOUTS



30° 5/16" clear spout without barbs	\$0.22
66090064	
<small>We recommend the use of the 5/16" drill bit for tapping.</small>	



30° 17/64" light blue spout without barbs	\$0.22
66090014	
<small>We recommend the use of the 17/64" drill bit for tapping.</small>	



30° 17/64" translucent blue spout with barbs	\$0.22
66090016	
<small>We recommend the use of the 17/64" drill bit for tapping.</small>	

ANTIBACTERIAL SPOUT



5/16" spout Zap-Bac Antibacterial	\$0.45
66090094	



Contains silver nanoparticles, approved by FDA. On request only.

Also available in 3/16" on request only.

MAXFLOW FITTINGS

The new line of **5/16" Maxflow fittings** was specifically designed and developed for maple producers wanting to operate over 25 in-hg (high vacuum). These fittings enable a perfect seal with a vacuum level **beyond 25 in-hg** and offers the following advantages:

- **No parting lines on the first barb.**
- Precision moulding.
- Eliminates micro-leaks caused by molding lines.
- Better grip on the tubing.



5/16" MAXFLOW SPOUTS



5/16" black spout with barbs
66090516 \$0.25

We recommend the use of a 19/64" drill bit for tapping.



5/16" white spout with barbs
66090517 \$0.25

We recommend the use of a 19/64" drill bit for tapping.



5/16" white spout without barbs
66090520 \$0.25

We recommend the use of a 19/64" drill bit for tapping.



5/16" blue spout with barbs
66090518 \$0.25

We recommend the use of a 19/64" drill bit for tapping.

17/64" MAXFLOW SPOUTS



17/64" black spout with barbs
66090514 \$0.25

We recommend the use of a 1/4" drill bit for tapping.



17/64" white spout with barbs
66090515 \$0.25

We recommend the use of a 1/4" drill bit for tapping.



17/64" white spout without barbs
66090512 \$0.25

We recommend the use of a 1/4" drill bit for tapping.



17/64" blue spout with barbs
66090513 \$0.25

We recommend the use of a 1/4" drill bit for tapping.

**White spouts,
7% better performance**



Did you know?

**ACCORDING TO A STUDY
FROM THE ACER CENTER**



When comparing sap yield, the white Maxflow spout gave a **sap volume 7% higher** than the black Maxflow spout.

CONCLUSION OF THE STUDY

In the studied sugarbush, white spouts gave a higher volume of sap compared to the black spouts.

This increase, recorded in the last part of the season, would be related to the color of the spout and its thermal absorption properties.



THE SOLUTION TO PREVENT MICRO-LEAKS

MAXFLOW FITTINGS

MAXFLOW TEES



5/16" health T
660300099 \$0.29



5/16" T with pin
66301099 \$0.29



5/16" multi-function T
660300096 \$0.29



5/16" T with sanitizing cap
66302099 \$0.36



17/64" health T
660300098 \$0.30

MAXFLOW END OF LINE ADAPTORS



5/16" end of line adaptor
66265099 \$0.37



End of line adaptor with cap
66266099 \$0.39



Maxflow multifunctional
end of line adaptor
66267099

5/16" MAXFLOW CONNECTORS



Round hook connector
(5/16" cable)
66011099 \$0.20



5/16" flat hook connector
66303099 \$0.20

MAXFLOW END OF LINE TEES



5/16" end of line health T
66306357 \$0.31



5/16" end of line T with pin
66305099 \$0.31



5/16" end of line T
with sanitizing cap
66304357 \$0.37



17/64" end of line health T
660300097 \$0.31



5/16" multifunction end T
66306358 \$0.32

MAXSEAL MULTI-FITTINGS / FIXED HEAD

Hole diameter: 31/64". Screw kit #66099099 not included.

Compressible gasket for maximum seal

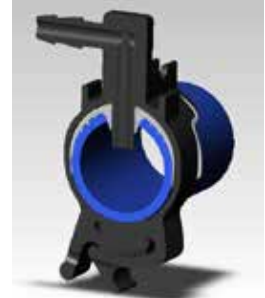

3/4" 66096096 \$2.20

1" 66097096 \$2.35



1 1/2" 66098096 \$2.80

Maxseal
single gasket 66091C \$0.25



Screw Kit
66099099 \$0.28

FITTINGS FOR TUBING



CDL REDUCERS AND SPOUT ADAPTORS ALLOW YOU TO REUSE AND EXTEND THE LIFESPAN OF YOUR PERMANENT SPOUTS WHILE MAXIMIZING EFFICIENCY.

REDUCERS AND ADAPTORS **CONTACT US FOR BULK PRICE!**



7/16" to 5/16" black reducer
66090054 \$0.23

Install on stubby spout 66090053. We recommend the use of a 19/64" drill bit for tapping.



5/16" black spout adaptor
66090099A \$0.21

We recommend the use of a 19/64" drill bit for tapping.



7/16" to 5/16" natural reducer
66090054N \$0.23

Install on stubby spout 66090053. We recommend the use of a 19/64" drill bit for tapping.



5/16" natural spout adaptor
66090099N \$0.22

We recommend the use of a 19/64" drill bit for tapping.



7/16" to 5/16" thin wall clear reducer
66090054M \$0.22

We recommend the use of a 5/16" drill bit for tapping.



5/16" clear adaptor with thin wall
66090099M \$0.18

We recommend the use of a 5/16" drill bit for tapping.



5/16" to 1/4" thin wall clear reducer
66090014M \$0.18



5/16" Zap Bac antibacterial adaptor
66090094A \$0.32

MULTI-FITTINGS / FIXED HEAD
HOLE DIAMETER: 5/16". SCREW KIT NOT INCLUDED.



3/4"	66096099	\$2.20
1"	66097099	\$2.35
1 1/4"	66098099	\$2.65



Screw kit 66099099 \$0.28

MULTI-FITTINGS / PLUG
Screw kit not included



3/4"	66094034	\$2.05
1"	66094091	\$2.30



Screw kit 66099099 \$0.28

Ideal to repair holes in mainlines or plug holes when you change the location of a multi-fitting.

MULTI-FITTINGS / SWIVEL HEAD
HOLE DIAMETER: 5/16"



1 1/2" 66064099 \$2.25



FITTINGS FOR TUBING

END OF LINE ADAPTORS



5/16" end of line hook
66279099 \$0.21



5/16" black Y
66014099 \$0.40



3/16" sliding adaptor
ERA1510 \$0.42



5/16" sliding adaptor
ETMAT316C \$0.45



5/16" sliding hook
ETMAT316CH \$0.27

OTHER



5/16" Rubber plug
6603509905 \$0.20



Health spout pin
66012099 \$0.13



Double forks

1/2"	66031099	\$2.60
3/4"	66032099	\$2.95
1"	66033099	\$3.90

SAP LADDER FITTINGS



5/16" 6-way star
66180 \$1.90



5/16" 3-way star
66183 \$1.90

5/16" CONNECTORS



Quick connector
6601209902 \$0.55



Connector with loops
6601109902 \$0.22

Y / PLASTIC



INS X INS X INS

3/4"	66074099	\$4.25
1"	66075099	\$4.25
1" x 1" x 3/4"	66066099	\$4.25
1 1/4" x 1 1/4" x 1"	66034098	\$4.95

SANITIZING 5/16" CAPS



5/16" black cap for MaxFlow
spouts
66030516 \$0.20



Clear sanitizing universal cap
CDL200 \$0.24
*Pieces sold separately. Customer assembly required.



Clear cap tip insertion
66030515 \$0.25



1/4" Clear cap tip insertion
66030514 \$0.25

PERFECT FOR SPOUT SANITATION

SPINSEAL

CDL EXCLUSIVE



Unbeatable sealing

VIDEO AVAILABLE ON



SpinSeal™ TECHNOLOGY

Save from \$1.80 to \$3.45 per lateral line compared to all other systems in the industry.

THE SPINSEAL TECHNOLOGY

THE CDL WAY TO SAVE TIME AND MONEY.

A REVOLUTIONARY SYSTEM FOR INSTALLING FITTINGS ON MAINLINE IN RECORD TIME!



CDL
16

The CDL way. The power of expertise. / 2019 catalog / cdusa.com



SpinSeal welder
730100

Price upon request



5/16" SpinSeal drilling template with drill bit
730101

\$85.00



7/32" CDL drill bit for 5/16" SpinSeal Fittings
66732

Price upon request

9/64" CDL drill bit for 3/16" SpinSeal Fittings
66964

Price upon request



5/16" GREY SpinSeal plug
66091059

\$0.79



5/16" BLUE SpinSeal Fitting
66091061

\$0.79



5/16" BLACK SpinSeal Fitting
66091069

\$0.79



5/16" GREEN SpinSeal Fitting
66091065

\$0.79



3/16" BLUE SpinSeal Fitting
66091041

\$0.79



3/16" BLACK SpinSeal Fitting
66091049

\$0.79

See page 19 for SPINSEAL™ tubing >

The reference in the maple syrup industry



5/16" 4-SEASONS TUBING

WARRANTY	COLOR	PRODUCT CODE	LENGTH
10 year	Blue	6600130805	500'
15 year	Blue	6600127209	500'
10 year	Green	6600137510D	500'
15 year	Green	6600137515	500'
10 year	Shadow grey	6600144010	500'
15 year	Shadow grey	6600142415	500'

ADVANTAGES OF 5/16" 4 SEASONS TUBING

- Unequaled translucency;
- Longest life expectancy on the market;
- Malleable in all temperatures;
- Resists falling trees, branches and freezing rain;
- No leakage on CDL fittings;
- Best warranty on the market.

TRANSLUCENCY / LONGEST LIFE / MALLEABLE / RESISTANT / NO LEAKAGE

PRECUT DROPS

10 year warranty	Clear	6600100036	36"
		6600100040	40"

Other colors and lengths available upon request.
Minimum quantity: 10 000 units



PRECUT DROPS

Our precut drops will save you work in the preparation of your drops.

Completely clear for an optimal visibility.

Again, the unique plastic recipe with UV stabilisers and an established reputation is offered to optimize yield and durability.

Available in 36 and 40 inch length, and packaged in bundles of 100 units.

5/16" TUBING



Ask your CDL representative about our in-store drop assembly service!

5/16" CDL TUBING

WARRANTY	BLUE	CODE	LENGTH	RIGIDITY
10 year	5/16" CDL Vision	451610021	500'	SEMI-RIGID
5 year	5/16" CDL MAX	451605011	500'	RIGID
10 year	5/16" CDL Flex	451610001	500'	SEMI-RIGID FLEX
15 year	5/16" CDL Flex	451615001	500'	SEMI-RIGID FLEX
10 year	5/16" CDL 50	451610031	500'	SEMI-RIGID RIGID
WARRANTY	DARK BLUE	CODE	LENGTH	RIGIDITY
10 year	5/16" CDL Vision	451610027	500'	SEMI-RIGID
15 year	5/16" CDL Vision	451615027	500'	SEMI-RIGID
10 year	5/16" CDL Flex	451610007	500'	SEMI-RIGID FLEX
15 year	5/16" CDL Flex	451615007	500'	SEMI-RIGID FLEX
WARRANTY	GREEN	CODE	LENGTH	RIGIDITY
10 year	5/16" CDL Vision	451610025	500'	SEMI-RIGID
5 year	5/16" CDL MAX	451605015	500'	RIGID
10 year	5/16" CDL Flex	451610005	500'	SEMI-RIGID FLEX
15 year	5/16" CDL Flex	451615005	500'	SEMI-RIGID FLEX
WARRANTY	SHADOW GREY	CODE	LENGTH	RIGIDITY
10 year	5/16" CDL Flex	451610006	500'	SEMI-RIGID FLEX
15 year	5/16" CDL Flex	451615006	500'	SEMI-RIGID FLEX

ADVANTAGES OF VISION TUBING

- Ideal for straight and long laterals.
- Good translucency.
- Keep its properties over the years

ADVANTAGES OF FLEX TUBING

- Flexible at all temperatures.
- Resists falling trees.
- No leakage.
- Permanent marking on tubing.

10 YEAR WARRANTY
get CDL quality!

MAINLINES AND PRE-LASHED MAINLINES

CDL PRE-LASHED MAINLINE

Factory pre-lashed with superior stainless steel wire. Save time with a 1-step installation!

Aluminum alloy
main wire

Stainless steel
support wire

Watch the pre-lashed
mainline video on  YouTube

SpinSeal

CDL SpinSeal MAINLINE 100 / PSI.
THICKER AND MORE FLEXIBLE. REMAINS FLEXIBLE EVEN IN COLD WEATHER.

PRODUCT	LENGTH	BLACK	BLUE	GREEN
3/4"	500'	403410069S	403410061S	-
	2 500' spool	403410169S	403410161S	-
	2 500' PRE-LASHED spool	403410169SL	403410161SL	-
1"	500'	410010069S	410010061S	-
	1 000'	410010269S	410010261S	410010265S
	1 500' spool	410010169S	410010161S	410010165S
	1 500' PRE-LASHED spool	410010169SL	410010161SL	410010165SL
1 1/4"	500'	411410069S	411410061S	-
	1 000' spool	411410169S	411410161SL	-
	1 000' PRE-LASHED spool	411410169SL	411410161SL	-
1 1/2"	500'	411210069S	411210061S	-
	900' spool	411210169S	411210161S	-
	900' PRE-LASHED spool	411210169SL	411210161SL	-

CDL HIGH DENSITY MAINLINE / 100 PSI (SUPERIOR QUALITY HIGH DENSITY RESIN. MORE RIGID THAN THE LOW DENSITY. LIGHT TUBING.)

PRODUCT	LENGTH	BLACK	BLUE	GREEN
3/4"	500'	403410069	403410061	403410065
	1 000'	403410269	403410261	403410265
	Bobine 2 500' spool	403410169	403410161	403410165
	Bobine 2 500' PRE-LASHED spool	403410169L	403410161L	403410165L
1"	500'	410010069	410010061	410010065
	1 000'	410010269	410010261	410010265
	1 500' spool	410010169	410010161	410010165
	1 500' PRE-LASHED spool	410010169L	410010161L	410010165L
1 1/4"	500'	411410069	411410061	411410065
	1 000'	411410269	411410261	411410265
1 1/2"	500'	411210069	411210061	411210065



MAINLINES

VERSAPIPE™ FUSION

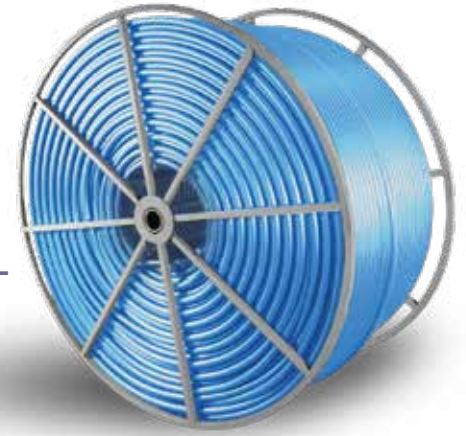

TITAN SPOOL

AERIAL/IN-GROUND HDPE TUBING

- > Fused joints are as strong as the tubing itself
- > More durable and flexible than PVC
- > Available on 2500 feet steel TITAN spools
- > Food grade and BPA-Free
- > 145 PSI

	LENGTH	BLACK	BLUE	GREEN
1"	500'	670020990500	670022720500	-
1"	1 500' spool	670020991500	670022721500	-
1¼"	500'	670030990500	670032720500	-
1¼"	1 000'	670030991000	670032721000	-
1½"	500'	661222920500	661222720500	-
1½"	2 500' spool	661222922500	661222722500	-
2"	500'	66230292	66230272	66230375
2"	2 500' spool	662302922500	662302722500	662303752500
3"	50' rod	66334292	66334272	-
3"	500'	663340990500	663342720500	-
4"	50' rod	663440990050	663432720050	-

BURIED



END TO END FUSION



WIRELESS MAINLINE TUBING

RAPITUBEV2™

TRANSLUSCENT BLUE

¾"	6600727250RT	500'
1"	6600827250RT	500'
1"	6600827227RT	3 000' spool

RAPI-FIX TENSION STRAPPING

Black	66300099	200'
-------	----------	------

Prices available upon request

Flexible and so simple!
100 PSI and quicker to install

Complete installation guide of RapiTubeV2™ is available on rapi-tube.com or on



7 YEARS OF CDL EXPERTISE!

ELECTRO SADDLES



1¼" x 1"	66130125X100
1½" x 1"	66130115X100
1½" x 1½"	66130115X150
2" x 1"	6613012X100
2" x 1¼"	6613012X12500
2" x 1½"	6613012X150
3" x 1"	6613013X100
3" x 1¼"	6613013X12500
3" x 1½"	6613013X1500
3" x 2"	6613013X200

ELECTRO REDUCERS



1" x ¾"	6613021X075
1½" x 1"	66130215X100
1½" x 1¼"	66130215X12500
2" x 1"	6613022X100
2" x 1½"	6613022X1500
2" x 1¼"	6613022X12500
3" x 2"	6613023X200
4" x 1¼"	6613024X12500
4" x 2"	6613024X200
4" x 3"	6613024X300

ELECTRO COUPLINGS



1"	661303100
1¼"	66130312500
1½"	6613031500
2"	661303200
3"	661303300
4"	661303400

ELECTRO T



1" x 1" x 1"	6613041X1X100
1¼" x 1¼" x 1¼"	661301125
1½" x 1½" x 1½"	661301150
2" x 2" x 2"	661301200
3" x 3" x 3"	6613043X3X300

ELECTROFUSION PURCHASE or LEASE

Ask your CDL sales representative about purchasing or leasing a welder.



For rent 10601LOC Purchase 10502

A LEAK FREE solution. FUSION system for aerial or buried tubing

- > Ultra quick installation of connectors.
- > Installation of connectors without cutting the tubing.

WIRE AND ACCESSORIES

WIRE AND ACCESSORIES

GALVANIZED

#9 50 lb	66040	\$79.45
#12 50 lb	66049	\$80.65
#14 50 lb	66051	\$86.55



HIGH TENSION

#12,5 50 lb	ETBR012.5HT	\$85.95
.134 high carbone 50lb	66054	\$83.50
Hydro aluminium # 10 50 lb	660301	Price upon request

LASHING WIRE

Stainless steel 1 200'	660660	\$46.10
------------------------	--------	---------



Medium gripple 10-14 GA	665503	\$1.85 / ea
---------------------------	--------	-------------



Large gripple 7,5-10 GA	665505	\$3.00 / ea
---------------------------	--------	-------------

Repair wire # 9	662000	\$3.70 / pair
-----------------	--------	---------------

Repair wire # 10	662001	\$3.70 / pair
------------------	--------	---------------

Repair wire 3/16"	662003	\$4.05 / pair
-------------------	--------	---------------

Repair wire for 1/4" cable	662004	\$4.55 / ft
----------------------------	--------	-------------

Steel cable 1/8"	60042	\$0.14/ft
------------------	-------	-----------

Steel cable 3/16"	60045	\$0.22/ft
-------------------	-------	-----------

Steel cable 1/4"	60043	\$0.38/ft
------------------	-------	-----------

1/8" cable clamp	66038	\$0.61
------------------	-------	--------

3/16" cable clamp	66036	\$0.57
-------------------	-------	--------

Screw eye bolt 1/2" x 5/4" x 1" zinc	664160	\$4.50
--------------------------------------	--------	--------

3/8" hook tensioning screw	667073	\$5.10
----------------------------	--------	--------

Galvanised steel ratchet ETMRAT01		\$4.99
-----------------------------------	--	--------

12,5 GA wire link WL12LINK		\$4.99
----------------------------	--	--------

Ratchet handle for wire ETMRAT02		\$9.95
----------------------------------	--	--------



WIRE TIES

REGULAR



5" 1000/pkg for 3/4" tubing	660851	\$11.20
---------------------------------	--------	---------

6" 1000/pkg for 1" tubing	660861	\$13.20
-------------------------------	--------	---------

7" 1000/pkg for 1 1/4" tubing	660871	\$14.25
-----------------------------------	--------	---------

8" 1000/pkg for 1 1/2" tubing	660881	\$16.30
-----------------------------------	--------	---------

10" 1000/pkg for 2" tubing	660811	\$18.50
--------------------------------	--------	---------

12" 2500/pkg	66400112	\$53.05
----------------	----------	---------

14" 2500/pkg for 3" tubing	66096	\$61.05
--------------------------------	-------	---------

5" 1000/pkg for 3/4" tubing	66085116	\$16.50
---------------------------------	----------	---------

6" 1000/pkg for 1" tubing	66086116	\$21.10
-------------------------------	----------	---------

7" 1000/pkg for 1 1/4" tubing	66087116	\$21.90
-----------------------------------	----------	---------

8" 1000/pkg for 1 1/2" tubing	66088116	\$23.15
-----------------------------------	----------	---------

10" 1000/pkg for 2" tubing	660810116	\$30.15
--------------------------------	-----------	---------

12" 2500/pkg	6640011216	\$80.73
----------------	------------	---------

14" 2500/pkg for 3" tubing	6609616	\$81.00
--------------------------------	---------	---------

18" 1000/pkg for 3" tubing	66423	\$45.15
--------------------------------	-------	---------



HEAVY DUTY

TENSION GRIP



OPEN

3/4"	663093	\$15.00	1"	663092	\$16.05
------	--------	---------	----	--------	---------

REGULAR













1/2"	663094	\$14.05	3/4"	663098	\$12.10
------	--------	---------	------	--------	---------

1"	663099	\$15.05	1 1/4"	663097	\$21.95
----	--------	---------	--------	--------	---------

1 1/2"	663096	\$33.60	2"	663095	\$56.40
--------	--------	---------	----	--------	---------

3"	663089	\$107.15
----	--------	----------





WIRE TOOLS

	CDL wire gripper 1 000 kg (wires #9-10) 667065	\$59.30		High tension wire cutter 73069		\$73.60
	Hydro wire gripper For #9-12 wires Limited quantity 667069	\$72.85		"Contractor" pliers for grippler installation 665504		\$137.75
	Spring loaded wire gripper 667068	\$82.30		Light clamp for grippler 665522		\$96.95
	Permanent wire gripper for path crossing 667066	 \$14.95		Manual wire twister 66090		\$6.05
	Crimping tool 665701	\$61.15		Automatic wire twister 66091		\$29.60

TOOLS FOR PRE-LASHED MAINLINES INSTALLATION

	Pre-lashed mainline retention hook 660604	\$40.75		Wire puller for pre-lashed mainline 660605	\$50.95		Pre-lashed mainline retention pulley 660603	\$193.95
---	---	---------	---	--	---------	---	---	----------

MARKING ACCESSORIES AND TOOLS



	Orange fluorescent tape 661015	\$1.99		NIKON hypsometer 550 forestry pro For slopes and distance 66064	\$615.00
	Pink fluorescent tape 661016	\$1.99		Topofil dispenser 661145	\$163.20
	Yellow fluorescent tape 661018	\$1.99		Thread for dispenser 9 900' 661146	\$7.40
	Blue fluorescent tape 661017	\$1.99		Sighting hand level 666566	\$40.75
	Long lasting spray paint			Mainline level hook 66902	\$64.15
	Pink 661140 Green 661141 Yellow 661142 Orange 661144 Red 661147 Blue 661149	\$8.10			

TOOLS

PLIERS FOR SPOUTS AND TUBING

	3/16" Compact insertion pliers Anti-ice jaws 73067	\$102.00		Stripping pliers Modified blade to facilitate cutting without breaking 73063	\$102.00
	Compact insertion pliers Anti-ice jaws 73062	\$102.00		Replacement blade 66502	\$23.30
	Stripping pliers 5 functions 664963	\$122.50		Repair pliers for 5/16" tubing ETPTR03C	\$91.80
	Serrated blade for 5/16" Pruno tool 66500	\$35.75		Repair pliers for 3/16" tubing ETPTR0316C	\$91.80
	Compact insertion pliers with knife and tubing stretcher 66559	\$121.20		1 1/2" & 1" tubing cutters 63001	\$20.35
	Compact insertion pliers 66558	\$109.45		2" tubing cutters 63005	\$20.55
	Blade - Lateral cutter for pruno tool 665579	\$9.10		5/16" nut driver 660911	\$9.15
	4WR compact pliers with blade 66557	\$111.75		FISKAR pliers 63FISK	\$15.25
				3/16" tension hooks 669103	\$12.75
				5/16" tension hooks 669104	\$12.75

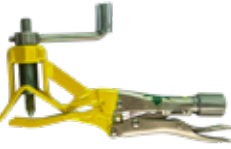
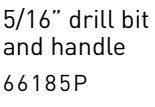
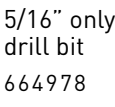
PUNCHES

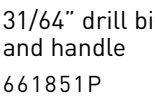
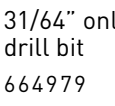
	5/16" Self-adjusting 73060	\$102.00		5/16" drill bit and handle 66185P	\$46.90		5/16" only drill bit 664978	\$14.05
	31/64" Self-adjusting 73059	\$102.00		31/64" drill bit and handle 661851P	\$55.05		31/64" only drill bit 664979	\$26.50

TOOLS FOR TUBING



30" Drop line cutter
668086 \$505.00

36" Drop line cutter
668089 \$605.00

40" Drop line cutter
668088 \$665.00

48" Drop line cutter
668048 \$765.00



5/16" Drop line pliers
66496 \$255.00

3/16" Drop line pliers
66497 \$270.00



Repair pliers with pivot
66501 \$107.00



5/16" Condensed fitting pliers
Lighter and compact model
73080 \$270.00



3/16" Condensed fitting pliers
Lighter and compact model
73081 \$270.00



Automatic Deluxe drop line pliers
662153 \$305.25

REELS



Galvanized mainline reel on wheels	660416	Price upon request
Toolbox (optional)	660417	
Wire reel (optional)	660418	



Horizontal for 5/16" tubing
660411 \$89.75



Vertical for 5/16" tubing
660410 \$131.10

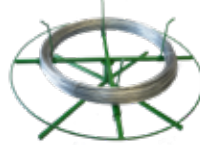

For wire
66041 \$172.95

MAINLINE DOUBLE FORK PLIERS



1" and 3/4"	662191	\$226.50
1 1/2" and 1"	66219	\$280.50
1 1/4" and 1"	662194	\$226.50
1 1/2" and 1 1/4"	662195	\$235.00
2" and 1 1/2"	662192	\$280.00
3"	662193	Price upon request
3/4" to 2" Kit	662196	\$410.75

TOOLS

DRILLS AND ACCESSORIES

CDL EXCLUSIVITY



20V Dewalt drill
663920 Price upon request



20V Dewalt battery
663925 Price upon request



12V-20V Dewalt charger
663921 Price upon request

The best tapping drill specifically designed for the maple syrup industry.

HEAD AT 90°

BRUSHLESS

2000 RPM

LONG LASTING 5A LITHIUM BATTERY



Catalog promotion on complete kit.

Bonus carrying bag
663920K Price upon request

DRILL BITS



7/16" titanium bit 66251 \$22.80

1/4" long bit 662415 \$25.00

19/64" long bit 662542 \$19.90

5/16" long bit 662540 \$19.90



DRILL BITS - SHORT HIGH PERFORMANCE



5/16" bit 662516 \$19.50

19/64" bit 66259 \$19.50

17/64" bit 66252 \$19.50

9/32" bit 66262 \$19.50

1/4" bit 662414 \$19.50

DRILL BITS - HIGH RESISTANT CDL TITAN (TITANIUM)

Durable and resistant to corrosion.



1.5X LONGER LIFETIME!

5/16" bit 662517 \$21,95

19/64" bit 662590 \$21,95

TAPPING ACCESSORIES



2 face tapping hammer
Aluminum handle
68041 \$23.30



Tapping hammer with blade
Aluminum handle
68042 \$31.30



12" wooden tapping hammer
729254045 \$6.05



CDL exclusivity

THE PRECISION TAPPER™



PERFECT ANGLE AND TAP HOLE DEPTH

PERFECT TAP, PERFECTLY AIRTIGHT.

NEW VIDEO AVAILABLE
WITH EVAN BRANON, MAPLE
PRODUCER AND INVENTOR



Precision Tapper™ kit

Includes: 1 drill, 2 batteries, 1 carrying bag and 1 precision template. *Tapping bit adaptor not included
663970

\$750.00



Precision Tapper™ adaptor

Installation included on your drill. Drill bit not included.
663971

\$395.00



Adaptors for drill bits

1/4" 6639714
19/64" 6639964
5/16" 6639716

\$79.95

PREVENT

- Damaged drill bits
- Inconsistency
- Oval holes
- Holes tapped too deep
- Handling errors

GET RID OF

- Vacuum loss
- Production loss
- High labor cost
- Unhealthy trees

PROFITABILITY STARTS FROM TREES!



27

TOOLS

WORK APRONS



Work apron 66932 \$75.25



NEW MODEL WITH REINFORCED SEAMS

CDL work apron 66934 \$175.00

LEAK FINDER



Revolutionary tool specifically designed for **pumping and vacuum stations.**

Finds leaks impossible to detect with the human ear, regardless of background noise, the temperature or the season.



EXCLUSIVE

Finds vacuum leaks:

- > Vacuum pumps
- > Reverse Osmosis
- > Tubing and valves
- > Cracks
- > Fitting joints
- > Extractors

Identification of the leak using a LED bar display combined with a sound signal.

SUPER SPECIAL

Leak finder kit 681010* \$295.00

*Includes: 1 leak finder, 1 pair of insulation and transfer earphones, 1 retractable neck support, 1 user manual, and 1 protection/carrying case. - 9V battery not included.

Earphones 681011 \$18.95



BRUSHES FOR BUCKETS AND SPOUTS

	For 1,5-gallon bucket 72940020	\$70.90
	For 2-gallon bucket 72940031	\$70.90
	For 7/16" interior spout 72940041	\$3.10
	For 7/16" interior spout 663562	\$4.20
	For 7/16" - 19/64" spout 663563	\$4.20

TUBE CLEANING SPONGES

	3/4" - 1"	661432	\$3.60
	1 1/2" - 1 1/4"	661433	\$3.60
	2"	661435	\$5.60
	3"	661436	\$5.90

SPOUT REMOVERS

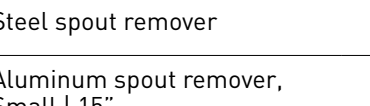
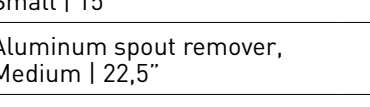
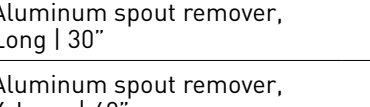
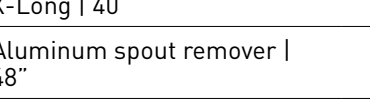



	A	Steel spout remover	66077	\$10.15
	B	Aluminum spout remover, Small 15"	68015	\$27.40
	B	Aluminum spout remover, Medium 22,5"	68020	\$28.50
	B	Aluminum spout remover, Long 30"	68030	\$32.00
	B	Aluminum spout remover, X-Long 40"	68040	\$36.70
	C	Aluminum spout remover 48"	68031	\$47.00
	C	Aluminum spout remover 60"	68032	\$52.00

BACKPACK CLEANING KIT

	Backpack cleaning kit with harness and dozer 661616	\$158.10
	Backpack cleaning kit with harness, without dozer 661612	\$107.15

More compact, lighter, more comfortable and specifically designed for maple sugaring.

Specifically developed by CDL for work under vacuum.

	Dozer gun only, 10 to 20 ml 661698	\$50.95
	Harness only 661691	\$67.35
	Replacement tube kit for CDL dozer 661692	\$6.65
	Three-piece kit for dispenser spout 661693	\$10.15
	Spring for CDL dozer 661694	\$1.02
	Scew cap for CDL dozer 661689	\$4.05

CLEANING TOOL

	CDL flow stopper pliers 73068	\$43.40
--	----------------------------------	---------

Autonomous sugarbush

CDL 4.0 VISION

Providing a 100% automated system from sap to barrel, establishing the **4th maple revolution**.



Maple sugaring beginnings

Installation of vacuum system (SYSVAC)

Mechanization era: modernization of boiling and concentration (High Brix), use of renewable energy

CDL 4.0 VISION

Autonomous sugarbush

Our Goal :

Full intelligent synergy of all the automated steps involved in producing maple syrup and its derivatives.

++ Performance ++

We believe this 4.0 industry vision will greatly help maple producers achieve unprecedented levels of production and will revolutionize the way things are done.

-Martin Chabot



MONITORING



MAKE THE MOST OF YOUR SUGARBUSH!

PERFORMANCE PER TAP

Improve performance by **1/2 lb per tap** while directly targeting your leaks.

DESIGNED BY MAPLE PRODUCERS, FOR MAPLE PRODUCERS

Simple to install, easy to use, our Monitoring technology is based on more than 25 years of experience.

SUPPORT AND SERVICE

For CDL, the support and service are just as important as the quality of the products.

Choosing CDL Monitoring means choosing an efficient and reliable system, designed exclusively for the management of your sugarbush.

MONITORING



MONITORING EQUIPMENT

Details on page 5

Monitoring starter kit 21090-FR



Vacuum sensor (single) SE100-V

Vacuum sensor (double) SE100-V-2

Communication gateway V2 SG100-V2



CDL control base 21082A



Flowmeter  631021



Tank level sensor SA100-HT

Tank level sensor holder 21120



Pump control 2 pumps SA100-M2

Pump control 4 pumps SA100-M4

Pump control 6 pumps SA100-M6



Ethernet communication module for lenze drive 21206



Digital HD camera IP20X 120M 20200



NEW!
Remotely read brix reader with CDL Monitoring!



NEW!

Integrated GPS and tracking.
Text message sent from the Wise-Mesh to the mobile app!
Compact design.
Contact us to learn more!



Portable gateway (sniffer)

Works with Wisemesh only.



PG200



Qi wireless charger and AC/DC adaptor PG200 assy



22201A



Cellular communication gateway

Support Canada and USA SIM card

Works with Wisemesh only.



SG200-C



Membrane switch SE100-V



21007



Multifunctions controller (in/out)

New and ultra-compact design.

Works with Wisemesh only.



SE200-M2

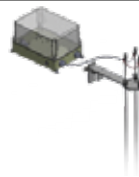

Tank level sensor kit

Allow automatic control of pressure pump



66551



Transfo AC/DC adaptor 5V 2 amp

21005



Motorized valve 120V ON/OFF 2" ferrule

668408S

Motorized valve 120V ON/OFF 2" ferrule

668409S

Motorized valve 120V ON/OFF 2½" ferrule

668410S

Motorized valve 120V ON/OFF 3" ferrule

668411S

More accessories available online or at your CDL store!

WISEMESH

 SMART MAPLE PRODUCTION NETWORK

10 ADVANTAGES OF THE ONLY SMART NETWORK 100% DEDICATED TO MAPLE SUGARING

The experience we have acquired through thousands of sensor installations means we can offer you a brand new MESH, **the only smart maple production network on the market.**



TURN YOUR SENSORS ON/OFF REMOTELY, ONLY WITH CDL



Full two-way communication and improved stability



CDL sensors do not need to be paired



CDL sensors come with a "sleep" mode that can remain active for up to 365 days and controlled remotely



Energy consumption reduced by 50%



CDL sensors remain active for 10 minutes and sleep for 20 minutes when they are not being checked, reducing energy consumption to 1.8 mA/h



Faster, more tailored data refresh rates



Installation allows you to check signal strength by walking through your woods



Employees and equipment can be monitored through the new communication system (Sniffer)



MESH can send text messages without a cellular network



Dynamics temperature report (tubing freeze)



Cloud technology - security and report and remote system updating



New- automated system integration (Season 2019)

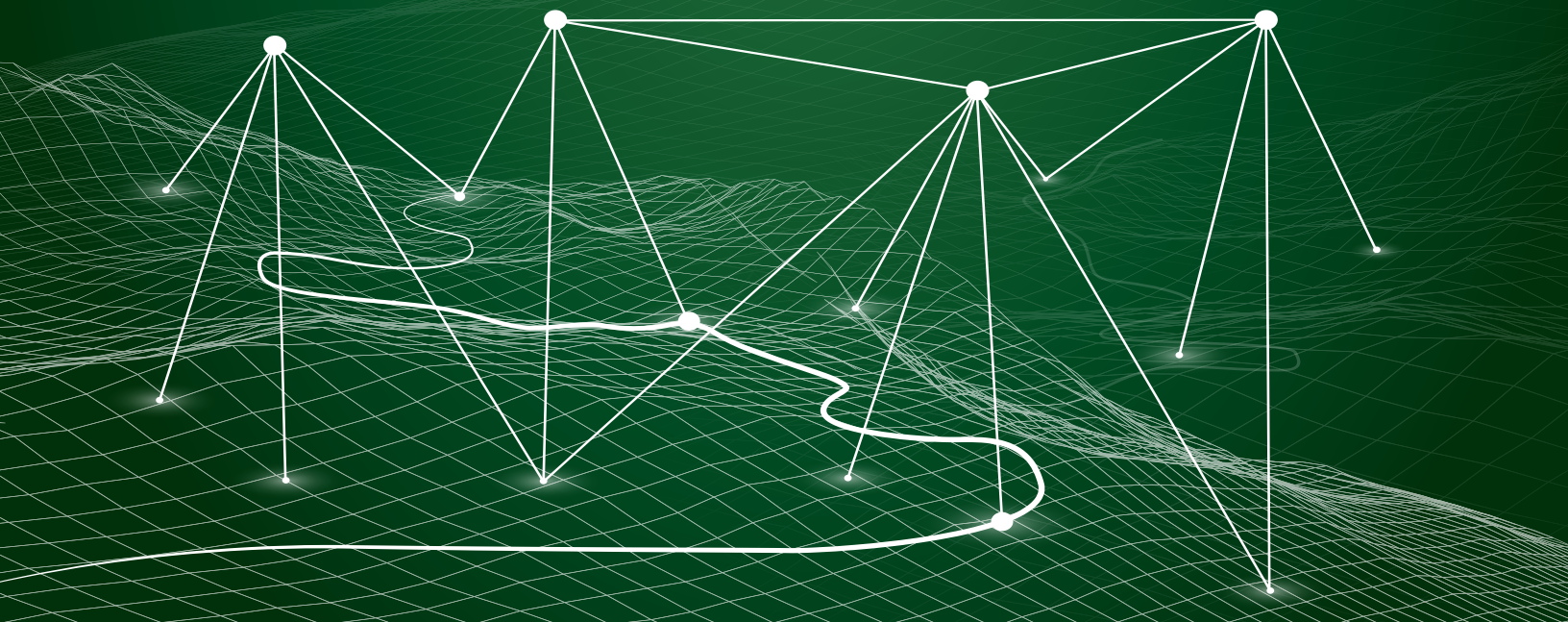

STAINLESS STEEL FITTINGS



A QUALITY THAT MAKES ALL THE DIFFERENCE!

A- CONNECTORS			
INS X INS			
3/4"	662034	\$4.30	
1"	662035	\$4.75	
1 1/4"	662037	\$5.00	
1 1/2"	662038	\$5.20	
2"	662039	\$8.95	
3"	662033	\$18.95	

B- REDUCERS			
INS X INS			
1" x 3/4"	665580	\$14.00	
1 1/4" x 3/4"	665586	\$15.75	
1 1/4" x 1"	665581	\$16.81	
1 1/2" x 3/4"	665587	\$17.15	
1 1/2" x 1"	665582	\$17.15	
1 1/2" x 1 1/4"	665599	\$17.15	
2" x 1"	665596	\$20.40	
2" x 1 1/4"	710150	\$23.10	
2" x 1 1/2"	665583	\$23.10	
3" x 2"	6655302	\$47.00	

C- ADAPTORS			
MIPT X INS			
1/2" x 5/8"	710563	\$14.25	
3/4"	665589	\$15.05	
1"	665592	\$16.30	
1 1/4"	665591	\$17.30	
1 1/2"	665590	\$18.30	
2"	665593	\$22.95	
3"	660003	\$50.95	

D- TEES			
INS X INS X INS			
1/2"	660503	\$19.95	
3/4"	7134341	\$20.35	
1"	6607527	\$21.40	
1 1/4"	6603106	\$22.40	
1 1/2"	6603105	\$24.00	
2"	6603108	\$30.55	
1" x 1" x 3/4"	660505	\$23.45	
1 1/4" x 1 1/4" x 3/4"	660317	\$23.70	
1 1/4" x 1 1/4" x 1"	6605061	\$24.00	
1 1/2" x 1 1/2" x 3/4"	660507	\$24.45	
1 1/2" x 1 1/2" x 1"	660506	\$24.45	
1 1/2" x 1 1/2" x 1 1/4"	730312	\$25.00	
2" x 2" x 3/4"	660508	\$27.50	
2" x 2" x 1"	730311	\$27.50	
2" x 2" x 1 1/4"	730314	\$27.80	
2" X 2" X 1 1/2"	660511	\$28.05	
3" X 3" X 1"	660520	On demand	

D- 1			
INS X INS X MIPT			
1"	66075251	\$30.55	
1 1/2" x 1 1/2" x 1"	730308	\$30.50	

D- 2			
INS X MIPT X INS			
3/4"	71343415	\$32.55	
1"	660515	\$25.45	
1 1/4"	66031066	\$49.95	
1 1/2"	66031056	\$60.15	

E- Y			
INS X INS X INS			
1/2"	6607531	\$21.00	
3/4"	6607507	\$21.00	
1"	6607501	\$22.40	
1 1/4"	6607510	\$24.45	
1 1/2"	6607508	\$26.50	
2"	6607509	\$30.85	
3"	6607522	On demand	
1" x 1" x 3/4"	660751	\$24.45	
1" x 3/4" x 3/4"	660752	\$32.60	
1 1/4" x 1" x 1"	6607511	\$33.60	
1 1/4" x 1 1/4" x 3/4"	6607518	\$26.00	
1 1/4" x 1 1/4" x 1"	6607512	\$26.50	
1 1/2" x 1" x 1"	66075191	\$35.65	
1 1/2" x 1 1/4" x 1 1/4"	6607515	\$37.70	
1 1/2" x 1 1/2" x 3/4"	6607520	\$26.50	
1 1/2" x 1 1/2" x 1"	6607516	\$26.50	
1 1/2" x 1 1/2" x 1 1/4"	6607505	\$27.50	
2" x 2" x 3/4"	6607514	\$29.55	
2" x 2" x 1"	6607513	\$29.55	
2" x 2" x 1 1/4"	6607519	\$31.60	
2" x 2" x 1 1/2"	6607503	\$31.60	
3" x 3" x 1"	66075130	On demand	
3" x 3" x 1 1/2"	66075128	On demand	
3" x 3" x 2"	66075129	On demand	

E- 1			
MIPT X INS X INS			
3/4"	66075121	\$25.95	
1"	66075122	\$27.50	

E- 2			
INS X MIPT X INS			
3/4"	66075124	\$26.50	

F- VACUUM ADAPTORS			
INS X MIPT X FIPT VACUUM			
1 x 1 1/4"	6655921	\$28.50	

G- HOOK PLUGS			
INS			
3/4"	666834	\$11.45	
1"	666801	\$10.20	
1 1/4"	666114	\$11.65	
1 1/2"	666112	\$11.10	
2"	666802	\$16.05	
3"	666803	\$21.50	
4"	666804	\$24.10	

H- BUTTERFLY VALVES			
1 1/2"	60T150		Price upon request
2"	60P88CC2		
2 1/2"	60T212		
3"	60T300		

I- QUICK COUPLINGS			
COMPLETE SET			
3/4"	662034SS	\$40.55	
1"	662015S	\$41.60	
1 1/4"	662014SS	\$46.80	
1 1/2"	662012SS	\$69.70	
2"	662025S	\$74.45	
INSERTION PART ONLY			
3/4"	736650	\$11.40	
1"	736651	\$12.45	
1 1/4"	736652	\$13.50	
1 1/2"	736655	\$20.75	
2"	736656	\$25.95	

CLIPS FERRULES			
QUICK			
1 1/2"	60R13C112	\$41.95	
2"	60R13C2	\$42.95	
2 1/2"	60R13C212	\$56.95	
3"	60R13C3	\$60.00	
HEAVY DUTY			
1 1/2"	60R13HC112	\$14.95	
2"	60R13HC2	\$15.95	
2 1/2"	60R13HC212	\$18.95	
3"	60R13HC3	\$24.95	
SCREW STYLE			
1 1/2"	60R13VT112	\$15.95	
2"	60R13VT2	\$16.95	
2 1/2"	60R13VT212	\$19.95	

SILICONE GASKETS FOR FERRULES			
1 1/2"	60GASKET112SILI	\$3.60	
2"	60GASKET2SILI	\$4.05	
2 1/2"	60GASKET212SILI	\$6.05	
3"	60GASKET3	\$6.40	

J- CLIPS X MIPT FERRULES			
1 1/2" x 3/4"	736654	\$17.30	
1 1/2" x 1"	6788991D1	\$18.30	
1 1/2" x 1 1/4"	770060	\$20.35	
1 1/2" x 1 1/2"	770024	\$22.95	
2" x 1 1/4"	60R14SW214	\$24.45	
2" x 2"	60R14SW22	\$31.10	
2 1/2" x 1 1/2"	60R14SW215	\$30.55	
2 1/2" x 2"	770049	\$33.65	

K- CLIPS X FIPT FERRULES			
1 1/2" x 3/4"	6788991D3	\$20.35	
1 1/2" x 1"	6788991D4	\$26.15	
2" x 1 1/4"	67THRE2X114ST	\$29.55	
2" x 1 1/2"	6598140	\$30.55	
2 1/2" x 2"	6598141	\$35.65	

Sharp edges for solid grip, precise machining, no restriction, get CDL quality!

THREADED STAINLESS STEEL FITTINGS

COUPLINGS



1/4"	6010FC025	\$2.50
3/8"	6010FC0375	\$2.50
1/2"	6010FC05	\$3.90
3/4"	6010FC075	\$5.60
1"	6010FC1	\$8.65
1 1/4"	6010FC125	\$12.20
1 1/2"	6010FC15	\$14.10
2"	6010FC2	\$14.30

TEES



FIPT		
1/4"	712525	\$3.55
3/8"	6010T0375	\$3.95
1/2"	711212	\$4.45
3/4"	713434	\$6.65
1"	711010	\$9.55
1 1/4"	6010T125	\$18.70
1 1/2"	6010T15	\$20.35
2"	6010T2	\$34.35

THREADED PLUGS



FIPT		
1/4"	SCA025	\$3.00
1/2"	SCA050	\$3.60
3/4"	6010BF34	\$3.65
1"	6010BF1	\$4.05
1 1/4"	SCA125	\$7.85
1 1/2"	SCA150	\$10.00
2"	SCA200	\$13.25



MIPT		
1/4"	6010B25	\$1.35
3/8"	6010B38	\$1.60
1/2"	6010B12	\$1.80
3/4"	6010B34	\$2.05
1"	6010B1	\$3.65
1 1/4"	6010B114	\$6.15
1 1/2"	6010B112	\$7.50
2"	6010B2	\$8.70

ELBOWS



90° FIPT X FIPT		
1/4"	6010914	\$3.20
3/8"	601090038	\$3.35
1/2"	601095	\$3.50
3/4"	6010975	\$3.90
1"	6010901	\$9.10
1 1/4"	601090125	\$12.95
1 1/2"	60109015	\$17.55
2"	6010902	\$27.05



90° MIPT X FIPT		
1/4"	6010913	\$2.85
3/8"	6010900375	\$3.65
1/2"	60109S05	\$4.85
3/4"	601090075	\$6.10
1"	601090	\$9.60
1 1/4"	601097	\$15.10
1 1/2"	601096	\$18.90
2"	601092	\$28.05



45° FIPT		
1/2"	S4E050	\$3.70
3/4"	S4E075	\$6.10
1"	S4E100	\$9.55
1 1/4"	S4E125	\$13.70
1 1/2"	60109415	\$17.85

NIPPLES



1/4" close	610151	\$2.60
1/4" x 3"	601104003	\$2.85
1/4" x 6"	SNI256	\$7.40
3/8" close	60150375C	\$3.10
3/8" x 2"	60382	\$3.50
3/8" x 2 1/2"	SNI3725	\$4.00
3/8" x 3"	60150383	\$4.05
3/8" x 4"	601503754	\$5.70
3/8" x 5"	SNI375	\$6.15
3/8" x 6"	SNI376	\$7.40
1/2" close	60150500C	\$3.20
1/2" x 1 1/2"	SNI051	\$4.00
1/2" x 2"	601105002	\$4.25
1/2" x 2 1/2"	6015150025	\$4.70
1/2" x 3"	60115003	\$4.95
1/2" x 4"	601105004	\$5.05
1/2" x 5"	60111501	\$8.10
1/2" x 6"	60115006	\$8.80
3/4" x close	60110750C	\$3.50
3/4" x 2"	601107502	\$4.05
3/4" x 3"	601107530C	\$3.30
3/4" x 4"	711005	\$5.75
3/4" x 5"	711015	\$5.95
3/4" x 6"	711003	\$7.85
3/4" x 8"	SNI758	\$15.75
1" close	60151000C	\$3.80
1" x 2"	601002	\$4.90
1" x 3"	60111003	\$6.10
1" x 4"	711004	\$7.40
1" x 5"	601110500	\$8.00
1" x 6"	601110006	\$10.90
1" x 8"	60118	\$20.40
1 1/4" close	60111250C	\$7.20
1 1/4" x 2 1/2"	601112525	\$10.90
1 1/4" x 3"	601112503	\$11.90
1 1/4" x 4"	711006	\$12.75
1 1/4" x 5"	SNI125	\$15.75
1 1/4" x 6"	711017	\$17.00
1 1/2" close	60111500C	\$7.40
1 1/2" x 2 1/2"	6011150025	\$11.20
1 1/2" x 3"	60111503	\$12.25
1 1/2" x 4"	711009	\$13.30
1 1/2" x 5"	SNI155	\$16.05
1 1/2" x 6"	601115006	\$17.85
1 1/2" x 8"	SNI158	\$27.25
2" close	60152000C	\$10.10
2" x 3"	SNI203	\$17.00
2" x 6"	601120006	\$19.40

Other lengths available:
12"-24"-48"-72"-96". Contact us.

REDUCERS



FIPT X FIPT		
1/4" x 3/8"	SC2537	\$5.15
1/2" x 1/4"	SC5025	\$6.40
1/2" x 3/8"	SC5037	\$6.40
3/4" x 1/4"	SC7525	\$8.60
3/4" x 3/8"	SC7537	\$9.20
3/4" x 1/2"	SC7550	\$9.60
1" x 1/4"	SC1025	\$12.70
1" x 3/8"	SC1037	\$12.70
1" x 1/2"	SC1050	\$12.70
1" x 3/4"	SC1075	\$12.70
1 1/4" x 1/2"	SC1250	\$19.15
1 1/4" x 3/4"	SC1275	\$19.15
1 1/4" x 1"	SC1210	\$19.15
1 1/2" x 1/2"	SC1550	\$20.70
1 1/2" x 3/4"	SC1575	\$20.70
1 1/2" x 1"	SC1510	\$20.70
1 1/2" x 1 1/4"	SC1512	\$20.70
2" x 1"	SC2010	\$26.50
2" x 1 1/2"	SC2015	\$26.50



MIPT X FIPT		
1/4" x 3/8"	711014	\$2.55
1/2" x 1/4"	715025	\$2.65
1/2" x 3/8"	705038	\$2.70
3/4" x 1/4"	713414	\$3.90
3/4" x 3/8"	713438	\$3.95
3/4" x 1/2"	713412	\$4.00
1" x 1/4"	714014	\$7.75
1" x 3/8"	SB1037	\$7.85
1" x 1/2"	711012	\$7.95
1" x 3/4"	711034	\$8.55
1 1/4" x 3/8"	SB1237	\$8.45
1 1/4" x 1/2"	665551	\$9.20
1 1/4" x 3/4"	714075	\$9.70
1 1/4" x 1"	714100	\$9.85
1 1/2" x 1/2"	712050	\$12.15
1 1/2" x 3/4"	712034	\$12.95
1 1/2" x 1"	711210	\$14.00
1 1/2" x 1 1/4"	712114	\$14.50
2" x 1/2"	SB2050	\$22.45
2" x 3/4"	711013	\$22.65
2" x 1"	711020	\$22.85
2" x 1 1/4"	711225	\$23.05
2" x 1 1/2"	712015	\$23.25

DRAW-OFF ELBOWS



MIPT		TUBE		
1/2"		3/4"	SDE050	\$23.05
3/4"		1"	SDE075	\$27.80
1"		1"	6788991D2	\$31.35
1 1/4"		1 1/2"	SDE125	\$35.10
1 1/2"		2"	SDE150	\$37.05

Sharp edges for solid grip, precise machining, no restriction, get CDL quality!

FITTINGS, VALVES AND PLUMBING



**PREMIUM
QUALITY**

QUICK COUPLINGS / POLYETHYLENE



PART A		
1/2"	6620102	\$4.10
3/4"	6620107A	\$4.10
1"	6620111	\$4.20
1 1/4"	6620109A	\$4.35
1 1/2"	6620110A	\$4.60
2"	66202A	\$5.65
3"	6620302	\$15.45



PART B		
1/2"	6620104	\$8.40
3/4"	6620107B	\$9.05
1"	6620118	\$11.15
1 1/4"	6620129	\$13.25
1 1/2"	6620137	\$13.80
2"	66202B	\$15.95
3"	6620103	\$26.50



PART C		
1/2"	6620140	\$9.35
3/4"	6620107C	\$10.00
1"	6620108	\$11.40
1 1/4"	6620109C	\$13.30
1 1/2"	6620110	\$13.40
2"	66202C	\$15.65
3"	6620305	\$26.80



PART D		
1/2"	6620106	\$9.70
3/4"	6620107D	\$9.70
1"	6620119	\$10.25
1 1/4"	6620120	\$13.00
1 1/2"	6620133	\$13.05
2"	66202D	\$16.00
3"	6620300	\$26.65



T FIPT X FIPT		
2"	63250	\$11.85
3"	63245	\$49.75



ELBOWS FIPT X FIPT		
2"	63252	\$8.85
3"	63244	\$37.70



COUPLINGS FIPT X FIPT		
2"	63249	\$12.80
3"	63246	\$28.70



PART E		
1/2"	6620141	\$4.45
3/4"	6620112	\$4.60
1"	6620113	\$4.80
1 1/4"	6620114	\$5.60
1 1/2"	6620115	\$5.75
2"	66202E	\$6.65
3"	6620309	\$19.55



PART F		
1/2"	6620105	\$4.55
3/4"	6620121	\$4.60
1"	6620122	\$5.10
1 1/4"	6620127	\$5.60
1 1/2"	6620128	\$5.90
2"	6620160	\$6.65
3"	6620306	\$19.45



PART DP		
3/4"	6620130	\$4.40
1"	6620123	\$4.60
1 1/2"	6620131	\$5.45
2"	6620138	\$6.35
3"	6620311	\$14.20



PART DC		
3/4"	6620134	\$9.50
1"	6620125	\$10.30
1 1/2"	6620135	\$13.05
2"	6620139	\$15.75
3"	6620144	\$25.40



GASKETS		
3/4"	6607901	\$1.20
1"	6607902	\$1.30
1 1/4" et 1 1/2"	6607903	\$1.35
2"	6607904	\$1.70
3"	6607905	\$2.55



REDUCERS MIPT X FIPT		
3" X 2"	63251	\$15.20



NIPPLES MIPT X MIPT		
2"	63248	\$9.10
3"	63247	\$23.60



BALL VALVES		
2" FIPT	63242	\$65.90
2" MIPT	63243	\$75.65
2" 3-WAY FIPT	710156	\$112.00
3" FIPT	63253	\$128.50

QUICK COUPLINGS / STAINLESS STEEL



A	3/4"	6620182	\$7.30
B	3/4"	6620180	\$14.60
C	3/4"	6620183	\$16.40
C	1 1/4"	6620158	\$30.55
C	1 1/2"	6620148	\$30,80



E	3/4"	6620184	\$9.65
E	1"	6620165	\$10.30
E	1 1/4"	6620157	\$17.70
E	1 1/2"	6620159	\$20.75
F	3/4"	6620181	\$8.30

FITTINGS, VALVES AND PLUMBING



A- COUPLINGS WITHOUT RESTRICTION

MIPT X INS		
3/4"	630100	\$3.95
1"	630101	\$4.05
1 1/4"	630102	\$4.85
1 1/2"	630103	\$5.05

B- ADAPTORS

INS X FIPT		
1/2"	64091	\$2.60
3/4"	64092	\$2.85
1"	64093	\$2.85
1 1/4"	64094	\$3.60
1 1/2"	64096	\$4.55
2"	63230	\$7.30

MIPT X INS		
1/2"	66195	\$0.55
3/4"	64054	\$0.71
1"	64056	\$0.75
1 1/4"	66198	\$1.22
1 1/2"	66199	\$1.25
2"	66200	\$2.35

C- REDUCING ADAPTORS

MIPT X INS		
1/2" x 3/4"	64053	\$1.75
1/2" x 1"	6605301	\$1.75
3/4" x 1/2"	64058	\$1.75
3/4" x 1"	63200	\$1.95
1" x 3/4"	66089	\$1.75
1" x 1 1/4"	63205	\$2.05
1" x 1 1/2"	63204	\$3.35
1 1/4" x 3/4"	64060	\$1.85
1 1/4" x 1"	64062	\$2.00
1 1/4" x 1 1/2"	63206	\$3.20
1 1/2" x 1"	64064	\$2.35
1 1/2" x 1 1/4"	64066	\$2.45
1 1/2" x 2"	63208	\$3.95
2" x 1 1/2"	63210	\$3.95

D- TEES

INS X INS X INS		
1/2"	66022	\$1.25
3/4"	66023	\$1.55
1"	66029	\$1.60
1 1/4"	6602801	\$2.45
1 1/2"	66030	\$2.75
2"	66033	\$5.60
1/2" x 1/2" x 3/4"	63150	\$3.30
3/4" x 3/4" x 1/2"	635002	\$2.50
3/4" x 3/4" x 1"	63152	\$2.85
1" x 1" x 1/2"	6602401	\$1.90
1" x 1" x 3/4"	66024	\$1.75
1" x 1" x 1 1/4"	66020	\$5.05
1 1/4" x 1" x 1/2"	6602001	\$3.00
1 1/4" x 1" x 3/4"	6602002	\$3.00
1 1/4" x 1" x 1"	6602003	\$3.00
1 1/4" x 1 1/4" x 1/2"	6602004	\$2.75
1 1/4" x 1 1/4" x 3/4"	66025	\$2.95
1 1/4" x 1 1/4" x 1"	66028	\$3.50
1 1/2" x 1 1/4" x 1"	66028011	\$3.90
1 1/2" x 1 1/4" x 1 1/4"	66028021	\$4.65
1 1/2" x 1 1/2" x 1/2"	6602803	\$3.70
1 1/2" x 1 1/2" x 3/4"	66026	\$3.80
1 1/2" x 1 1/2" x 1"	66027	\$3.85
1 1/2" x 1 1/2" x 1 1/4"	66021	\$4.00
2" x 1 1/2" x 1 1/2"	6602101	\$6.45
2" x 2" x 1/2"	6602102	\$5.35
2" x 2" x 3/4"	6602103	\$5.35
2" x 2" x 1"	66357	\$5.35
2" x 2" x 1 1/4"	6602105	\$5.35
2" x 2" x 1 1/2"	6602106	\$5.70

INS X INS X MIPT		
3/4" x 3/4" x 3/4"	678483	\$2.10
1" x 1" x 1"	678484	\$2.80
1 1/4" x 1 1/4" x 1 1/4"	678485	\$3.40
1 1/2" x 1 1/2" x 1 1/2"	6602804	\$3.70
2" x 2" x 2"	660331	\$6.15

INS X INS X FIPT		
3/4" x 3/4" x 1/2"	6602901	\$1.60
1" x 1" x 1/2"	6602701	\$2.00
1 1/4" x 1 1/4" x 1/2"	66025010	\$2.70
1 1/2" x 1 1/2" x 1/2"	6602601	\$4.20

E- CONNECTORS

INS X INS		
1/2"	66012	\$0.60
3/4"	66013	\$0.70
1"	66014	\$0.70
1 1/4"	66015	\$1.00
1 1/2"	66016	\$1.30
2"	63220	\$2.20

F- REDUCERS

INS X INS		
3/4" x 1/2"	66069	\$0.95
1" x 1/2"	66066	\$1.20
1" x 3/4"	66065	\$1.25
1 1/4" x 3/4"	66092	\$1.80
1 1/4" x 1"	66073	\$1.80
1 1/2" x 3/4"	66093	\$2.25
1 1/2" x 1"	63175	\$2.25
1 1/2" x 1 1/4"	66078	\$2.25
2" x 1"	63222	\$3.05
2" x 1 1/4"	63225	\$3.05
2 x 1 1/2"	66067	\$3.10

G- 90° ELBOWS

INS X INS		
1/2"	66045	\$1.05
3/4"	66046	\$1.30
1"	64068	\$1.85
1 1/4"	64070	\$1.80
1" x 3/4"	64073	\$2.10
1 1/2"	64072	\$1.85
2"	66666	\$2.70
3"	66677	\$20.40

INS X FIPT		
3/4" x 1/2"	63156	\$1.20
1" x 1/2"	64071	\$1.30

H- CAPS

INS		
1/2"	66076	\$0.95
3/4"	66043	\$1.00
1"	66059	\$1.40
1 1/4"	66060	\$1.80
1 1/2"	66061	\$1.90
2"	66062	\$4.05

FITTINGS, VALVES AND PLUMBING

VALVES



PVC

BALL VALVES (FIPT)		
1/2"	63100	\$2.80
3/4"	63105	\$3.30
1"	63110	\$4.35
1 1/4"	63115	\$6.40
1 1/2"	63120	\$9.15
2"	63125	\$11.75
3"	63128	\$51.55



PVC

GATE VALVES (SLIP)		
1"	66175031	\$15.20
1 1/2"	6617504	\$15.25
2"	6617506	\$21.40
3"	6617507	\$30.55
4"	6617509	\$127.55



Stainless Steel

BALL VALVES (FIPT)		
1/4"	6617053	\$16.30
3/8"	601438	\$18.30
1/2"	601412	\$20.35
3/4"	601475	\$26.50
1"	6013TBV21	\$34.65
1 1/4"	601414	\$54.05
1 1/2"	601415	\$71.40
2"	6013TBV22	\$107.30



Stainless Steel

VALVES À BILLE (INS X INS)		
3/4"	66177075	\$18.95
1"	66177100	\$20.85



3-WAY VALVES (OSMOSE)

3/4"	71017	\$85.00
1"	71014	\$93.50

PVC TU BALL VALVE



SP		
1"	6618106	\$19.25
1 1/2"	6618107	\$33.45
2"	6618108	\$48.55
SP + FIPT		
1"	6618109	\$22.00
1 1/2"	6618110	\$39.40
2"	6618111	\$56.40



PVC

BALL VALVES HEAVY DUTY (FIPT)		
1/2"	63100R	\$4.35
3/4"	63105R	\$4.85
1"	63110R	\$5.90
1 1/4"	63115R	\$7.90
1 1/2"	63120R	\$10.70
2"	63125R	\$13.30
3"	63128R	\$56.10

CLAMPS



Brass screw

HF-10 (3/4")	66082	\$0.66
HF-16 (1")	66083	\$0.67
HF-20 (1 1/4")	660831	\$0.68
HF-24 (1 1/2")	66084	\$0.71
HF-32 (2")	6608401	\$0.77



Stainless steel screw

HS-10 (3/4")	660822	\$0.74
HS-16 (1")	6608301	\$0.76
HS-20 (1 1/4")	6608311	\$0.86
HS-24 (1 1/2")	660841	\$0.89
HS-32 (2")	60HAS32	\$1.05



Heavy duty

1"	660848	\$2.05
1 1/4"	660838	\$2.15
1 1/2"	660849	\$3.05
2"	660843	\$3.27
3"	660842	\$4.45
4"	660854	\$6.95



Heavy duty stainless steel

1"	660848S	\$3.95
1 1/4"	660838S	\$4.05
1 1/2"	660849S	\$5.75
2"	660843S	\$6.05
3"	660842S	\$7.20



For flexible hose

1 1/2"	660846	\$7.40
2"	660847	\$9.55

SINGLE UNION VALVES



PVC

FIPT X FIPT		
1"	6618100	\$17.40
1 1/2"	6618101	\$26.50
2"	6618102	\$38.25



PVC

SLIP		
1"	6618103	\$16.55
1 1/2"	6618104	\$18.30
2"	6618105	\$26.50

COMPLETE SELECTION AVAILABLE IN STORE!

FITTINGS, VALVES AND PLUMBING

CHECK VALVES



SLIP X SLIP CLEAR PVC		
1½"	6607112	\$33.65
2"	660702	\$48.45
3"	660703	\$85.35

FIPT X FIPT CLEAR PVC		
½"	660712	\$28.15
¾"	660734	\$31.10
1"	660701	\$32.15
1¼"	660714	\$33.60
1½"	660715	\$36.70
2"	660716	\$52.55



FIPT X FIPT		
½"	660731	\$22.45
¾"	660733	\$22.40
1"	660711	\$23.40



SLIP X SLIP		
½"	660735	\$25.00



SWING CHECK VALVES		
¾"	71013	Price upon request
1"	71011	
1½"	660706	
2"	660705	

CROSSES (SLIP)



1"	6608152	\$4.25
1½"	6608153	\$6.60
2"	6608154	\$8.05
2½"	6608156	\$10.45
3"	6608155	\$12.00

Y (SLIP)



1"	6613149	\$3.50
1½"	6613150	\$6.75
2"	6613152	\$16.20
3"	661330	\$25.05

90° ELBOWS



SP X SLIP		
1¼"	66147	\$2.30
1½"	66088152	\$2.40
2"	665530	\$4.40
3"	665499	\$9.50
4"	63214	\$16.30



MIPT X SLIP		
1"	631982	\$1.40
1½"	66088154	\$1.90
2"	665527	\$4.65



FIPT X SLIP		
1"	631981	\$0.90
1½"	66088151	\$1.55
2"	665532	\$3.95
3"	665528	\$14.30
4"	63216	\$24.75



SLIP X SLIP		
1"	63207	\$0.75
1¼"	661471	\$1.20
1½"	66088150	\$1.25
2"	665526	\$1.75
2½"	665543	\$5.70
3"	665534	\$6.35
4"	63203	\$9.95



FIPT X FIPT		
½"	63190	\$0.90
1"	63192	\$2.80
1¼"	63193	\$2.45
1½"	63194	\$3.05



90° ELBOW (SP X FIPT)		
1½"	66088160	\$2.75



MIPT X FIPT		
½"	63196	\$1.05
¾"	63197	\$1.45
1"	63198	\$2.00
1¼"	63163	\$2.40
1½"	63166	\$2.65
2"	64086	\$5.10
3"	665512	\$17.25



22.5° ELBOWS (SLIP X SLIP)		
1½"	66088156	\$2.70
2"	665540	\$4.15
3"	665529	\$12.25



45° ELBOWS (SLIP X SLIP)		
1"	63130	\$1.05
1¼"	63131	\$1.20
1½"	66088153	\$1.65
2"	665531	\$2.15
3"	665536	\$12.55
4"	63215	\$23.15

FITTINGS, VALVES AND PLUMBING

ADAPTORS



SP X FIPT			
1"	63015		\$1.40
1½"	66068154		\$2.00
2"	665585		\$2.45
3"	6606806		\$9.75



SLIP X INS			
1"	63011		\$1.20
1½"	665557		\$2.30
2"	6655461		\$5.05



FIPT X SLIP			
1"	63012		\$0.60
1½"	66068153		\$1.45
2"	665546		\$2.45
2½"	6606804		\$3.10
3"	6606803		\$3.75
4"	664094		\$9.90



MIPT X SLIP			
1" x 1"	63010		\$0.70
1¼" x 1¼"	63014		\$2.25
1½" x 1½"	66068150		\$1.25
2" x 2"	665525		\$1.35
2½" x 2½"	665547		\$5.40
3" x 3"	6606801		\$5.60
4" x 4"	665506		\$8.15

TEES



FIPT X FIPT X FIPT			
½"	63177		\$1.85
¾"	63182		\$2.95
1"	63180		\$3.95
1¼"	63178		\$4.50
1½"	63179		\$5.35
2"	63181		\$7.15



SLIP X SLIP X SLIP			
1"	63184		\$1.10
1½"	66058150		\$1.60
2"	665545		\$2.15
3"	664565		\$9.40
4"	664599		\$15.95



SLIP X SLIP X FIPT			
1"	631801		\$1.35
1½"	66058151		\$2.55
2"	665637		\$3.20



PVC SADDLE			
1" x 1" x 1"	6645303		\$1,30
1½" x 1½" x 1½"	6645304		\$2,50
2" x 2" x 2"	6645305		\$4,25
3" x 3" x 2"	6645306		\$13,50

CAPS



SLIP			
1"	669734		\$0.50
1½"	630351		\$0.80
2"	668820		\$0.95
3"	66881		\$3.05
4"	66882		\$8.60



MIPT			
¼"	66053		\$0.80
½"	66052		\$0.85
¾"	6606101		\$0.90
1"	6606102		\$1.40
1¼"	6606103		\$1.55
1½"	63035		\$1.70
2"	66058		\$2.15
2½"	660585		\$3.70
3"	66884		\$5.15
4"	66885		\$9.70



FIPT			
½"	660521		\$0.70
¾"	660801		\$0.85
1"	660802		\$1.35
1¼"	660586		\$1.70
1½"	630352		\$2.15
2"	660583		\$2.55
2½"	660584		\$3.90
3"	660806		\$4.10

FITTINGS, VALVES AND PLUMBING

REDUCERS



MIPT X FIPT		
1/2" x 1/4"	66975	\$1.80
3/4" x 1/4"	660777	\$1.25
3/4" x 1/2"	63185	\$1.25
1" x 1/4"	63051	\$1.65
1" x 1/2"	66973	\$1.35
1" x 3/4"	63050	\$1.30
1 1/4" x 1/2"	63171	\$1.70
1 1/4" x 1"	63170	\$1.80
1 1/2" x 3/4"	66976	\$2.40
1 1/2" x 1"	66977	\$2.65
1 1/2" x 1 1/4"	66974	\$2.70
2" x 3/4"	669782	\$2.55
2" x 1"	669791	\$2.55
2" x 1 1/4"	66978	\$2.55
2" x 1 1/2"	66979	\$2.60
2 1/2" x 2"	6697951	\$9.90\$



SP X SLIP		
1 1/2" x 1"	669783	\$1.25
1 1/2" x 1 1/4"	660481	\$1.25
2" x 3/4"	669787	\$1.90
2" x 1 1/2"	662545	\$2.15
2 1/2" x 1 1/2"	669795	\$2.90
2 1/2" x 2"	669794	\$2.90
3" x 1 1/2"	669786	\$3.05
3" x 2"	679799	\$3.05
3" x 2 1/2"	669796	\$4.45
4" x 2"	669788	\$7.35
4" x 3"	669778	\$6.55

CONNECTORS



SLIP X SLIP		
1"	66452	\$0.55
1 1/2"	66098150	\$0.75
2"	665535	\$1.05
3"	668831	\$3.60
4"	668835	\$6.35

ADHESIVES AND TEFLON



SP X FIPT		
1 1/2" x 3/4"	66078151	\$2.05
1 1/2" x 1"	66078150	\$2.05
1 1/2" x 1 1/4"	66078152	\$2.05
2" x 3/4"	66078275	\$2.50
2" x 1"	66078201	\$2.65
2" x 1 1/4"	66078153	\$2.70
2" x 1 1/2"	66078250	\$2.75
3" x 2 1/2"	660101	\$3.05
4" x 3"	6625475	\$6.55



SLIP X SLIP		
1 1/4" x 1"	66990	\$1.70
1 1/2" x 1"	669779	\$2.35
2" x 1 1/2"	669797	\$2.70
3" x 2"	669793	\$12.45



MIPT X SLIP		
1 1/4" x 1 1/2"	66068151	\$2.00
2" x 1 1/2"	66068152	\$2.80
2 1/2" x 3"	6606802	\$5.65

QUICK CONNECTORS



SLIP X SLIP		
1"	66699	\$4.40
1 1/4"	667003	\$10.25
1 1/2"	66700	\$13.30
2"	66701	\$15.55
3"	66702	\$32.20
4"	667044	\$48.95



FIPT X FIPT		
1"	66698	\$7.35
1 1/4"	667004	\$11.95
1 1/2"	6670012	\$14.30
2"	667012	\$15.60
3"	66693	\$29.55

A	FusionPro tape, 2,5 cm x 3 m	661300	\$5.50
B	PVC glue, 118 ml	667055	\$4.25
B	PVC glue, 473 ml	667056	\$11.40
C	Teflon, 1/2" x 40' (10 m)	64100	\$0.77
D	Blue Monster TEFLON TAPE 1/2" x 1429"	64102	\$6.65
D	Blue Monster TEFLON TAPE 3/4" x 1429"	64104	\$7.90
E	Pink Teflon, 1/2" x 45' (10 m)	64105	\$3.65
<small>Pink Teflon, 1/2" x 45' (10 m) Pink Teflon is designed for plumbing, it's more resistant than white Teflon.</small>			
F	Grey Teflon, 1/2" x 260"	64106	\$3.65
<small>Grey Teflon is designed for stainless steel fittings</small>			

FITTINGS, VALVES AND PLUMBING

PVC RIGID PIPES



Sold in 10' or 20' length

WHITE			
1"	6645100		\$1.15
1½"	6645006		\$1.35
2"	6645020		\$1.75
3"	6645011		\$3.65
4"	664513		\$5.15

*Price by foot



Sold in 8' length

CLEAR			
1½"	6625601040		\$4.85
2"	6625801040		\$5.90

*Price by foot

PVC FLEXIBLE PIPES



Not approved food grade

1"	6645101	\$1.85
1½"	6645001	\$2.05
2"	6645002	\$2.85
3"	6645003	\$14.65

*Price by foot

PVC STRAPS



1"	667401	\$0.76
1¼"	667413	\$0.90
1½"	667415	\$1.20
2"	667420	\$1.80
3"	667430	\$3.85

HOSES

CLEAR FLEXIBLE VACUUM



¾"	66450512	\$3.00/ft
1"	6645051	\$3.50/ft
1¼"	664504	Upon request
1½"	664505	Upon request
2"	6614922	Upon request
3"	664503	Upon request

1/8" CLEAR THIN WALL



¾"	6600300	\$1.45/ft
7/8"	660078 *	\$2.50/ft
1"	66004001	\$2.00/ft
1-1/8"	660112 *	Upon request
1¼"	664507	Upon request

Not recommended for vacuum (maximum 30 PSI)
* Use on CDL reverse osmosis

FLEXIBLE HIGH PRESSURE



¾"	66243	\$1.65/ft
1"	6600400	\$2.60/ft
1¼"	6600500	Upon request
1½"	66006099200	\$5.90/ft
2"	661491	\$7.25/ft

100 PSI and more (pressure)
For pressure pumps

1/4" CLEAR THICK WALL



¾"	660030012001	\$3.85/ft
1"	660040012001	\$4.45/ft
1¼"	660050992001	\$5.60/ft
1½"	660060992001	\$8.50/ft
2"	66149	\$8.80/ft

Can be used with vacuum (50 to 60 PSI maximum)
Maximum 24 inches of mercury.

RUBBER COUPLINGS AND CLAMPS



COUPLINGS

1¼"	66094	\$5.45
1½"	669050	\$5.65
2"	669051	\$6.90
3"	669058	\$9.10
4"	669060	\$11.25



REDUCERS

1½" x 1¼"	66099	\$5.65
2" x 1½"	66098	\$6.90
4" x 2"	669054	\$14.30
3" x 4"	669059	\$14.70

1/4" POLYETHYLENE TUBING



TUB. 1/4" POLYETHYLENE

1/4"	661415	\$14.70/ft
------	--------	------------

*Price by foot

HOSES FOR FILTER PRESSES

A

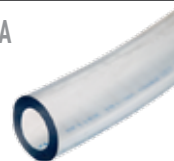

B



A	Clear 5/8"	6600210	\$2.55/ft
A	Clear 1"	6600110	\$6.65/ft
B	5/8" High temperature high pressure	66285	\$7.70/ft

Use between the pump and the plates.

SPRINKLER FOR SELF-CLEANING EXTRACTORS

NEW IN 2019!

SELF-CLEANING EXTRACTORS

OUR EXTRACTORS ARE NOW AVAILABLE
WITH A SPRINKLER FOR SELF-CLEANING!



THIS OPTION MAY ALSO BE INSTALLED
ON YOUR EXISTING EXTRACTORS!*

* Requires external pump and plumbing (not included)



360° CLEANING EFFICIENCY



CONTACT US FOR DETAILS!

EXTRACTORS WITH SUBMERSIBLE PUMP

Perfect for HIGH VACUUM

HORIZONTAL EXTRACTORS WITH SUBMERSIBLE PUMP TANK DESIGN

The specified measurement is the distance between the base of the extractor and the center of water entry.

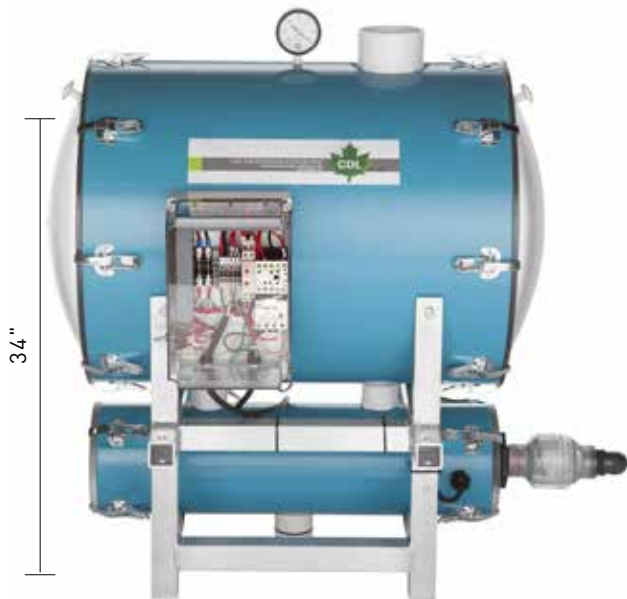

Can be installed on a tank or on the ground.

18" x 24"	2024ES	1/2 HP
18" x 36"	2024ES2	2 HP

: AVAILABLE IN 3 PHASES 208V, 460V ET 575V.

Pressure gauge not included.
Prices available upon request.

ADVANTAGES

- No sap-return in the 5/16" tubing.
- High quality submersible pump.
- Can be installed on a tank to allow drainage by gravity during shutdown periods.
- No air in the tubing system while extracting sap.
- Solves the sap extraction problems caused by pumping at high vacuum.
- No float, extremely reliable.



HORIZONTAL EXTRACTORS WITH SUBMERSIBLE PUMP

The specified measurement is the distance between the base of the extractor and the center of water entry.



18" x 48"	204820ES	1/2 HP
18" x 48"	204820ES2	2 HP
18" x 48"	204820ES2LP	1 x 2 HP Low pressure
18" x 48"	204820ES2D	2 x 2 HP
18" x 48"	204820ES2DLP	2 x 2 HP Low pressure
18" x 60"	206020ES3	3 x 2 HP
18" x 60"	206020ES3LP	3 x 2 HP Low pressure
18" x 60"	206020ES4	4 x 2 HP
18" x 60"	206020ES4LP	4 x 2 HP Low pressure

Pressure gauge not included

Prices available upon request

: AVAILABLE IN 3 PHASES 208V, 460V ET 575V.



Extractor grid kit	7200082A	48 "
Extractor grid kit	7200083A	60 "



ADVANTAGES

- No sap-return in the 5/16" tubing.
- High quality submersible pump.
- No air in the tubing system while extracting sap.
- Solves the sap extraction problems caused by pumping at high vacuum.
- No float, extremely reliable.

EXTRACTORS WITH SUBMERSIBLE PUMP

LOW HORIZONTAL EXTRACTORS

The specified measurement is the distance between the base of the extractor and the center of water entry.



12" x 24" ⚡	1224ES	1 x ½ HP	NEW
18" x 24" ⚡	2024ES2LP	1 x 2 HP Low pressure	NEW
18" x 36"	1836ES	½ HP	
18" x 36" ⚡	1836ES15	1 ½ HP	
18" x 48" ⚡	2048ES2	2 HP	
18" x 48" ⚡	2048ES2LP	1 x 2 HP Low pressure	NEW
18" x 48" ⚡	2048ES2D	2 x 2 HP	
18" x 48" ⚡	2048ES2DLP	2 x 2 HP Low pressure	NEW

Pressure gauge not included

Prices available upon request

⚡ : AVAILABLE IN 3 PHASES 208V, 460V ET 575V.



ADVANTAGES

- Very low (only 24" from the ground)
- No sap-return in the 5/16".
- High quality submersible pump.
- No air in the tubing system while extracting sap.
- Solves the sap extraction problems caused by pumping at high vacuum.



New model!

12" x 24"

1224ES

Ideal for 0 up to 1000 taps at 29Hg.

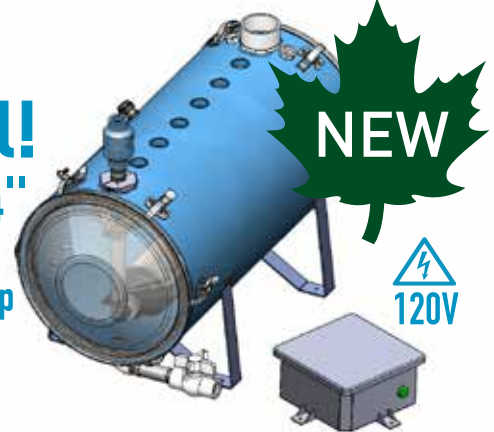

Submersible conversion kits available.

VERTICAL EXTRACTORS WITH SUBMERSIBLE PUMP

The specified measurement is the distance between the base of the extractor and the center of water entry.



ADVANTAGES

- Opening on top for easy cleaning.
- No sap-return in the 5/16" tubing.
- High quality submersible pump.
- No float, extremely reliable.
- No air in the tubing system while extracting sap.
- Solves the sap extraction problems caused by pumping at high vacuum.



	Without manifold	With manifold	
18" x 40"	2036ES	203608ES	½ HP
18" x 40"	2036ES2 With converter	203608ES2	1 ½ HP
18" x 40"	2036ESD	203608ESD	2 x ½ HP
18" x 40"	2036ES2D With converter	203608ES2D	2 x 1 ½ HP



Pressure gauge not included

Prices available upon request

EXTRACTORS

MECHANICAL EXTRACTORS

The specified measurement is the distance between the base of the extractor and the center of water entry.

		
15"	21"	20"
4 1 1/2" openings	4 1 1/2" openings 2 1" openings	8 1 1/2" openings
12" x 12" 121208 750 taps	12" x 18" 121808 3 000 taps	12" x 24" 122408 4 000 taps



ADVANTAGES

- Quick evacuation of the sap.
- No-maintenance mechanism.
- Stainless steel fleet.
- Openings at both extremities to ease cleaning.
- Non bonded, dismountable cylinder.





18" x 24" 202608	Measure: 26"	6 000 taps	8 1 1/2" openings
18" x 24" 202612	Measure: 28"	12 000 taps	8 1 1/2" openings
18" x 36" 203612	Measure: 28"	20 000 taps	No openings

Pressure gauge not included

Prices are available upon request

ELECTRICAL EXTRACTORS

The specified measurement is the distance between the base of the extractor and the center of water entry.

			
15"	21"	23 1/2"	30"
No openings	4 1 1/2" openings 2 1" openings	4 1" openings	8 1 1/2" openings for the 24" 12 1 1/2" openings for the 36"
12" x 18" 1000 taps 121808ESM	12" x 18" 1000 taps 121808E	12" x 24" 3000 taps 122406E	18" x 24" 202606E 4 000 taps 18" x 36" 203606E 6 000 taps 18" x 36" 2 outlet double float 203606ED 10 000 taps

Pressure gauge not included

Prices are available upon request

MOISTURE TRAPS AND VACUUM BOOSTER TANKS

HIGH VACUUM MOISTURE TRAP



Designed for high vacuum, this moisture trap captures water particules in the air that are not normally retained by conventional traps. It offers better protection for your pumps than other models on the market.



CDL 3" high vacuum moisture trap mechanical/electrical 710607 \$1195.00



Filtration union 7106071 Price upon request

MOISTURE TRAPS



A	CDL 2" moisture Trap	6610508	\$210.00
B	CDL 3" moisture Trap	710605	\$280.00
C	CDL 3" moisture Trap with electrical shutoff	710606	\$375.00

REPAIR PARTS

 Snaps D-2000 folded 662641P \$3.25

 Hinge and spring kit for extractors 662481 \$12.50

VACUUM PROTECTION VALVE 668411



Price upon request

The vacuum protection valve safely prevents sap overflow in your moisture trap or your vacuum pump without shutting vacuum down.

VACUUM BOOSTER TANKS THICK WALL

HORIZONTAL



Pressure gauge included

6" x 18"	721806	\$225.00
6" x 24"	722406	\$235.00
8" x 18"	721808	\$235.00
8" x 24"	722408	\$250.00
12" x 18"	721812	\$295.00
12" x 24"	722412	\$365.00
12" x 36"	723612	\$405.00
12" x 48"	724812	\$425.00
18" x 24"	722418	\$550.00
18" x 36"	723618	\$825.00

VERTICAL



Pressure gauge included

6" x 18"	720618	\$190.00
8" x 18"	720818	\$205.00
12" x 18"	721218	\$285.00
12" x 24"	721224	\$300.00
12" x 36"	721236	\$345.00

SAP LIFTERS



Simple sap filter	300 taps	73015
Double sap filter	600 taps	73017
Triple sap filter	1 200 taps	73018

Entrust our experts to drill additional entries at low cost.



47

CONVERSION SYSTEMS AND VACUUM PUMPS

CONVERSION SYSTEM FOR LIQUID RING PUMPS

For liquid ring close-coupled pumps



High vacuum 29" Hg

For single or double liquid ring pumps



Oil cooling system	1,5 to 5 HP	663460
	7,5 to 20 HP	663461

ADVANTAGES

- No more need for water or heating.
- No on-site assembly required.
- Compact and low maintenance.
- Independant oil tank.
- Adapted for low or high vacuum (15" Hg to 29" Hg)

VACUUM SCREW PUMPS



Screw vacuum pump a/copco 7.5hp ghs350vsd 460/3ph	6694075
Screw vacuum pump a/copco 10hp ghs585VSD 460/3ph	6694010
Screw vacuum pump a/copco 15hp ghs730vsd 460/3ph	6694000
Screw vacuum pump a/copco 20hp ghs900vsd 460/3ph	6694020
Screw vacuum pump a/copco 30hp ghs1300vsd 460/3ph	6694030
Food grade oil atlas copco pump 5 gal	663570

CONVERSION SYSTEM FOR VANE PUMPS



For DeLaval - Airablo pump

ADVANTAGES

- Eliminates overheating of the DeLaval or Airablo pumps
- Very compact.
- Allows to pump up to 25" Hg
- High performance radiator to keep the oil cooler.
- Integrated thermostat optimizes performance.

Oil cooling system	3 to 5 HP	663470P
	7,5 to 10 HP	663470

TWO-STAGE LIQUID RING PUMPS

High vacuum 29" Hg



SiHi 3 HP, assembled	66130
SiHi 5 HP, assembled	66131
SiHi 7,5 HP, assembled	66132
SiHi 10 HP, assembled	66133

PUMPS WITH GAS MOTOR



DeLaval VP76 pump with Honda 5,5 HP	668584
-------------------------------------	--------

Can be installed with a high vacuum cooling system.

Available models: 500 to 10 000 taps

DIAPHRAGM PUMPS

(IDEAL FOR SMALL PRODUCERS)

A



Source : 120 volts

B



A	Single diaphragm pump	Up to 400 taps	669512
B	Double diaphragm pump	Up to 700 taps	669514

ADVANTAGES

- Pumps up to 22" Hg.
- Works without a sap extractor.
- Easy to use and very compact.

Prices are available upon request

AIRTECH[®] VACUUM

THE BEST PUMP IN THE INDUSTRY!

Designed to reach up to 29.9" Hg

OTHER POPULAR BRAND: MAX 28.4" HG

AIRTECH VANE PUMPS L-SERIES

The best investment for your sugarbush!

Go from 25 to 29 Hg vacuum
and improve production by 20%!

Going from 3.5 to 4.2 lb per tap means:
\$21,000 more income / year for 10 000 taps!
\$63,000 more income / year for 30 000 taps!



PERFORMANCE COMPARISON

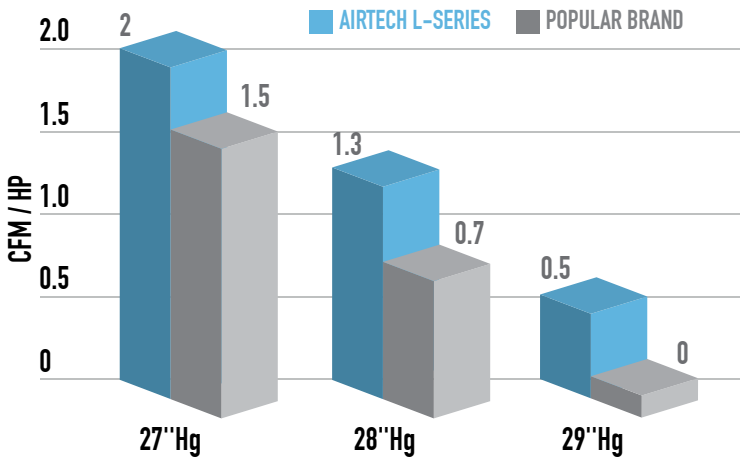

VERY COMPACT AND QUIET
LOW MAINTENANCE

Available from 1 to 10HP in single and 3 phases models

AIRTECH PUMP L25 1.5 HP 240V 1PH ASS.	L25G41.5HP
AIRTECH PUMP L40 2.0 HP 240V 1PH ASS.	L40G42HP
AIRTECH PUMP L40 2.0 HP 208-460V 3PH ASS.	L40G12HP
AIRTECH PUMP L63 3.0 HP 240V 1PH ASS.	L63G43HP
AIRTECH PUMP L63 3.0 HP 208-460V 3PH. ASS.	L63G13HP
AIRTECH PUMP L100 5.0 HP 240V 1PH ASS.	L100G45HP
AIRTECH PUMP L100 5.0 HP 208-460V 3PH ASS.	L100G15HP
AIRTECH PUMP L160 5.0 HP 240V 1PH ASS.	L160G45HP
AIRTECH PUMP L160 5.0 HP 208-460V 3PH ASS.	L160G15HP
AIRTECH PUMP L230 7.5 HP 240V 1PH ASS.	L230G475HP
AIRTECH PUMP L230 7.5 HP 208-460V 3PH ASS.	L230G175HP
AIRTECH PUMP L250D 10.0 HP 208-460V 3PH ASS.	L250DG110HP

LIQUID RING CLOSED-COUPLED PUMPS 3AV SERIES

AIRTECH[®] VACUUM

Does not require a strap or couplings.
ISO 9001 manufacturing and stainless steel rotor.

Designed to reach up to 29" Hg.

Very compact and
energy efficient design



AIRTECH PUMP 3AV55 3.0 HP 208-460V 3PH ASS	68303A
AIRTECH PUMP 3AV55 3.0 HP 240V 1PH ASS	68300A
AIRTECH PUMP 3AV130 5.0 HP 208-460V 3PH ASS	68503A
AIRTECH PUMP 3AV130 7.5 HP 240V 1PH ASS.	68500A
AIRTECH PUMP 3AV155 7.5 HP 208-460V 3PH ASS.	68753A
AIRTECH PUMP 3AV255 10.0 HP 208-460V 3PH ASS	68103A
AIRTECH PUMP 3AV330 15.0 HP 208-460V 3PH ASS.	681503A
AIRTECH PUMP 3AV430 20.0 HP 208-460V 3PH ASS.	68203A

VACUUM PUMP ACCESSORIES

ADJUSTABLE CARTS FOR L-SERIES VACUUM PUMPS

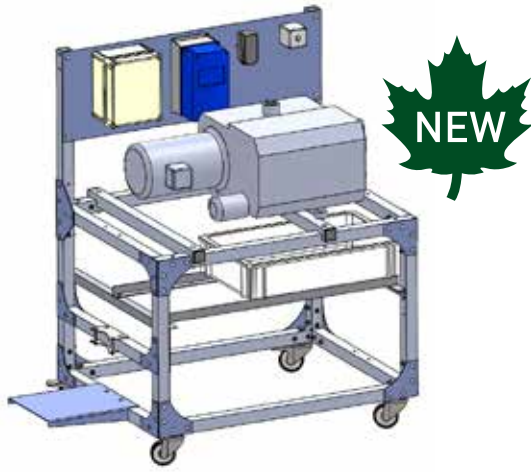

Adjustable cart for vacuum pump
L25-L40-L63-L100
6660100

Adjustable cart for vacuum pump
L160-L230-L250
6660200 Prices are available upon request

VACUUM REGULATOR



721212 \$115.00

OIL FOR RECLAIMERS



High vacuum oil,
18,9 L
Grade 32
663532 \$72.95

Oil recommended by 

VACUUM OIL FOR VANE PUMPS



Vacuum oil, 10 L
Grade 60
Ideal for DeLaval pump
Without reclaimer
663549 \$55.95

Oil recommended by 

PHASE CONVERTERS



	230V → 208V 1 → 3 PHASE CONVERTER	3 PHASE DRIVE
1.5 HP	66111DA	-
2 HP	66112DA	-
3 HP	66113DA	-
5 HP	66115DA	-
7,5 HP	66129DA	-
10 HP	66118DA	66115DA
15 HP	66015DA	66129DA
20 HP	66120DA	66118DA

Prices are available upon request

AUTOMATIC STARTERS



Temperature
controlled
automatic starter
669375 \$160.00



Manual adjustment kit
for converter
68100 \$225.00



Vacuum Transmitter
probe
GRD1632 \$195.00

OIL FOR AIRTECH PUMPS



Vane pump oil 22
5 GAL.
663520 \$150.00

Oil
recommended by 



Gear pump oil
Airtech VCX, 1L
68AT03000 \$19.95



Synthetic oil for
Airtech L-Series
pumps, 1L
68AT0400001 \$21.25

4L, 68AT0400002 \$72.50

20L, 68AT0400004 \$349.95

GAUGES AND PRESSURE PUMPS

GAUGES

Vacuum



2,5" 0-30 HG SS
64011SS \$32.00

4" 0-30 HG SS
3 % precision \$54.00
66120SS

Digital vacuum



0-30 HG
64019 \$190.00

Pressure



2,5" 0-100 PSI
SS bottom outlet \$32.00
64010SS

2,5" 0-100 PSI
SS rear outlet \$35.10
64016SS

Glycerin pressure

2,5" 0-100 PSI
SS bottom outlet \$32.10
66330SS

2,5" 0-100 PSI
SS rear outlet \$36.20
66331SS

2,5" 0-200 PSI
SS bottom outlet \$32.10
66339SS

2,5" 0-200 PSI
SS rear outlet \$36.20
663349SS

2,5" 0-600 PSI
SS bottom outlet \$32.10
663348SS

2,5" 0-600 PSI
SS rear outlet \$36.20
66337SS

2,5" 0-1 000 PSI
SS bottom outlet \$32.10
64014SS

2,5" 0-1 000 PSI
SS rear outlet \$36.20
66500210SS



Stainless steel
rear outlet

PRESSURE PUMPS (VACUUM)

GOULD PUMPS NPE SERIES

1/2 hp	669033	1 st
3/4 hp	669003	1 st
1 hp	669000	1 st
1 1/2 hp	669001	1 st
2 hp	669006	1 st
3 hp	669007	1 st
1 hp	669026	2 st
1 1/2 hp	669011	2 st
2 hp	669020	2 st
3 hp	669021	2 st
1 hp	669027	3 st
1 1/2 hp	669028	3 st
2 hp	669024	3 st
3 hp	669022	3 st

Prices are available upon request

1 st: Water inlet 1 1/2" and
water outlet 1" | 40 GPM

2 st: Water inlet 1 1/2" and
water outlet 1 1/2" | 80 GPM

3 st: water inlet 2" and
water outlet 1 1/2" | 120 GPM



E-SV Series
available upon request



GOULD PUMPS GB SERIES

5 GPM	665GB10	1 hp
7 GPM	667GB10	1 hp
10 GPM	6610GB10	1 hp
10 GPM	6610GB15	1 1/2 hp
10 GPM	6610GB20	2 hp
18 GPM	6618GB10	1 hp
18 GPM	6618GB15	1 1/2 hp
18 GPM	6618GB20	2 hp
18 GPM	6618GB30	3 hp
25 GPM	6625GB10	1 hp
25 GPM	6625GB15	1 1/2 hp
25 GPM	6625GB20	2 hp
25 GPM	6625GB30	3 hp

Up to 67 PSI. Call one of our experts to determine the speed and power of your pump.

For special cases,
up to 475 PSI and 700GPM

Flow rate from 5 to 33GPM.
Up to 250 PSI

Prices are available upon request



51

STAINLESS STEEL TANKS

ROUND BOTTOM TANKS LARGE CAPACITY

**MORE THAN 125 SIZES AVAILABLE
FROM 1 000 to 7 500 gallons.
Complete listing at www.cdusa.com**

ADVANTAGES

- Strong high quality welds allow complete sanitizing
- Made of bright 304 stainless steel.



**Built-in ladder
at each end.**

**Elevated 6"
for easier
plumbing**

Prices are available upon request

ROUND BOTTOM TANKS SMALL CAPACITY

Many sizes available: 50 to 1 000 gallons.



Prices are available upon request

EXTRACTOR SUPPORTS

SUPPORT KITS		
2' wide	672078	\$125.00
3' wide	672079	\$198.00
4' wide	672080	\$200.00
5' wide	672081	\$220.00
6' wide	6720821	\$240.00
7' wide	672082	\$275.00

**All of our extractor supports can be adjusted
to the desired depth.**



Stainless steel

**Personalize your tank!
Contact us for more information.**

Product appearance may vary.

TANK-WASHER WITH REMOTE CONTROL



Innovative feature!



Labor-saving automated
tank washing

Several sizes available. Contact your CDL representative!



53

Isolated syrup calibration tank



- Isolated tank
- Integrated mixer
- Integrated washing system
- Trolley on wheels
- Real-time brix reader
- Circulation pump
- 2 available modes



250 GAL.	6793443	4' X 4' X 3'
350 GAL.	6793445	4' X 4' X 4.5'
Isolated calibration tank starter control case		6793001

TANK LEVEL CONTROL



5' level control for CDL tanks
73500 \$336.75

6' level control for CDL tanks
73500-6 \$341.85

ADVANTAGES

- The CDL tank level controls are made entirely of stainless steel.
- In addition, you can very quickly and easily adjust the desired sap level where the pump will start.
- The solidity of CDL controls prevent breakage caused by ice.

Perfect syrup calibration at a controlled temperature!



Real-time Brix reader

0 to 80 Brix!

Homogenize syrup before filling barrels!

Automatic temperature compensation for accurate reading.

Can read between 5°C and 100°C (41°F-212°F)

24-volt power supply. Requires a circulation pump
May be installed on piping.

PLUGS



FOR TANKS			
1½"	5' rod	678112	\$90.30
2"	5' rod	678123	\$91.65
3"	3' rod	67BOUCH37	\$109.20

ADAPTORS



FOR PLASTIC TANKS		
½"	RA5012	\$14.05
¾"	RA5032P	\$17.80
1"	RA5034P	\$20.90
1¼"	RA5036P	\$23.50
1½"	RA50309P	\$26.25
2"	RA5042P	\$28.10
3"	RA5454P	\$39.40



FOR STAINLESS STEEL TANKS		
1¼"	668673	\$102.05
1½"	66867	\$107.15
2"	668672	\$112.35

UNIVERSAL MIXER AND STAINLESS STEEL SUPPORT



Universal mixer for 4', 5', 6' and 7' wide tank

6792034

Adjustable stainless steel support
1/2HP Motor at 30 RPM,
115 Volts with 10' of electric cord.

Note: a cut in length may be required to adjust the height. Prices are available upon request.



**NOT IN STOCK IN THE USA
UPON REQUEST ONLY**

TANKS AND ACCESSORIES

VERTICAL PLASTIC TANKS



**Adaptors and
level indicator included.**

US GALLONS DIAMETER X HEIGHT PRODUCT CODE

LARGER BASE

100	28" x 43"	VER100
305	46" x 50"	VER305
550	67" x 42"	VER550
1 100	87" x 53"	VE1100
1 550	87" x 67"	VE1550
1 700	87" x 74"	VE1700
2 100	87" x 89"	VE2100
2 500	95" x 91"	VE2500
3 000	95" x 109"	VE3000

SMALLER BASE

25	18" x 29"	SPS025
50	18" x 53"	SPS050
65	23" x 43"	SPS065
75	23" x 49"	SPS075
105	23" x 63"	SPS105
165	31" x 56"	SPS165
200	30" x 72"	SPS200
250	30" x 89"	SPS250
300	36" x 79"	SPS300
500	48" x 73"	SPS500
750	48" x 103"	SPS750
1 000	64" x 80"	SP1000
1 500	64" x 116"	SP1500

HORIZONTAL PLASTIC TANKS



**Adaptors and level indicator included.
Galvanized bands not included.**

US GALLONS DIAMETER X HEIGHT LID SIZE OUTLET PRODUCT CODE

35	20" x 23" x 29"	5"	3/4"	HOR035
55	23" x 26" x 34"	5"	3/4"	HOR055
65	23" x 27" x 43"	5"	3/4"	HOR065
125	32" x 35" x 42"	8"	2"	HOR125
225	38" x 41" x 49"	8"	2"	HOR225
325	38" x 43" x 68"	16"	2"	HOR325
425	49" x 54" x 60"	16"	2"	HOR425
525	49" x 54" x 71"	16"	2"	HOR525
725	49" x 54" x 101"	16"	2"	HOR725
1 025	49" x 54" x 139"	16"	2"	HOR102
1 625	63" x 68" x 139"	16"	2"	H01625

ELLIPTICAL

1 335	67" x 57" x 122"	16"	2"	EL1335
1 635	71" x 58" x 142"	16"	2"	EL1635
2 035	84" x 56" x 142"	16"	2"	EL2035
2 635	90" x 72" x 140"	16"	2"	EL2635
3 135	88" x 80" x 150"	16"	2"	EL3135

Prices are available upon request



55

TANKS AND ACCESSORIES



**NOT IN STOCK IN THE USA
UPON REQUEST ONLY**

PICKUP TRUCK TANKS



US GALLONS	DIAMETER X HEIGHT	LID SIZE	OUTLET	CODE	PRICE
210	51" x 39" x 28"	8"	2"	PUP210	Price upon request
325	62" x 49" x 33"	8"	2"	PUP325	Price upon request
425	65" x 49" x 39"	8"	2"	PUP425	Price upon request

SPECIAL APPLICATION

Prices are available upon request



Applicator tank

Available size: 12 US gallons.



PCO tank

Available sizes: 30 to 300 US gallons.

TANK STRAINER BASKETS



For 5" cover	STBA05	\$19.35
For 8" cover	STBA08	\$50.95
For 12" cover	STBA12	\$58.10
For 16" cover	STBA16	\$91.80

REPLACEMENT LIDS AND COLLARS

16" solid, non-ventilated cover	LIDP16S	\$43.40
16" ventilated, requires central cover	LIDP16	\$45.85
5" ventilated, for center of 16" cover	LIDPV5	\$13.20
12" solid, non-ventilated cover	LIDP12	\$41.35
8" solid, non-ventilated cover	LIDP08	\$29.55
5" ventilated 16" cover	LIDP05	\$22.40
8" threaded replacement collar	COL008	\$16.85
12" threaded replacement collar	COL012	\$17.10
16" threaded replacement collar	COL016	\$17.30



LA FENDEUSE CLASSIC RO (500 GPH TO 1 500 GPH)

**Get the best
price / efficiency
ratio with this new RO**

CDL quality and performance

ADVANTAGES

- CDL's most cost-efficient way to reach great performance
- Easier access for maintenance
- Unique, powerful, patented recirculation system that increases membrane life and requires little maintenance
- Top quality stainless steel

LA FENDEUSE DELUXE RO (500 GPH TO 3 600 GPH)

**The most
efficient
on the market**

Best recirculation system

ADVANTAGES

- Entirely made of stainless steel
- The most powerful and effective on the market today
- Continuous osmosis with low membrane plugging, allowing a concentration of up to 18 Brix for a whole day. (depending on the number of membranes)
- Individual flow reading for each membrane
- Unique, powerful, patented recirculation system that increases membrane life and requires little maintenance
- Our 5 and 7,5 hp high pressure pumps offer the highest flow on the market



600-gallon Osmosis

20+ REVERSE OSMOSIS



Concentration capacity adapted to your needs

20+ RO (CAPACITY OF 7 600 GPH AT 20 BRUX)



The 20+ reverse osmosis allows continuous concentration at over 20 Brix without premature plugging of the membranes.

In addition, it allows for very fast rinsing of each membrane to ensure efficient washing.

100% efficiency of the entire sugar season.

ADVANTAGES

- Designed to fit through a standard size door
- New 10HP turbine designed by CDL allowing high flow at high pressure.

16" POSTS

16" POST
Capacity over 2400 gallons per hour

Increase
your flow or performance by adding a
16" post to your system
Less electrical amperage required



Vertical



Horizontal

ADVANTAGES

- Eliminates complex plumbing.
- Major energy savings.
- Space saving.
- Easy to operate.
- Can replace more than four 8" posts.
- Maintenance free submersible pump.
- Superior performance with series of reduced posts.

Prices are available upon request

POST CARTS

Vertical



New 1.5 HP turbine installed on vertical or horizontal cart, preventing membranes from plugging at high Brix.

Can easily be added to an existing CDL RO with or without cart.



ADVANTAGES

- Facilitates post + membrane movement.
- Allows the simultaneous moving of the posts into a room with more space to assemble the membranes.
- Designed to fit inside a standard size door.

Horizontal



ADVANTAGES

- Compact
- Ultra simple connections
- Easy to operate
- Easy access to the membranes

25+ OPTIONS AND HIGH BRIX

CDL is the only manufacturer that offers custom configurations to upgrade your standard RO to make it to a High Brix system.



100% CDL custom technology

The CDL intelligent RO,
the most powerful and evolved in
the maple industry.

Customize
yours!



Performance

2 to 35 brix

600^{GPH} to 14 000^{GPH}



HT +
HIGH FLOW



CDL's unique patented recirculation system
doubles the performance of membranes.

**FULL RANGE OF
CUSTOMIZABLE RO
SYSTEMS TO FIT YOUR
PRODUCTION NEEDS.**



REMOTE MAINTENANCE AND SUPPORT

Get CDL specialized expertise quickly!



**DOSING PUMP FOR ACID
AND SOAP MANAGEMENT**



**SMART SOFTWARE
UPDATES**

CDL's intelligent RO's receive regular wireless software updates that add new features.

**INTELLIGENT
MANAGEMENTS**

-
- 🍁 CONCENTRATE BRIX MONITORING
- 🍁 MAPLE SAP BRIX MONITORING
- 🍁 PERMEATE FLOW READING
- 🍁 PH MONITORING AND CONTROL
- 🍁 CONDUCTIVITY METER
- 🍁 PREVENTIVE MANAGEMENT (PLUGGING)
- 🍁 LOW PRESSURE PROTECTION
- 🍁 HIGH PRESSURE PROTECTION

INTERNET OF THINGS



- 🍁 Full remote management
- 🍁 Compatible and supported by CDL Monitoring technology
- 🍁 Integrated computer enabling remote maintenance and support (reducing on-site technician service)
- 🍁 Touchscreen
- 🍁 LED



.....

**The most advanced technology
choice on the market**

30+ REVERSE OSMOSIS



Double the concentration

Can be paired or combined with your existing RO.

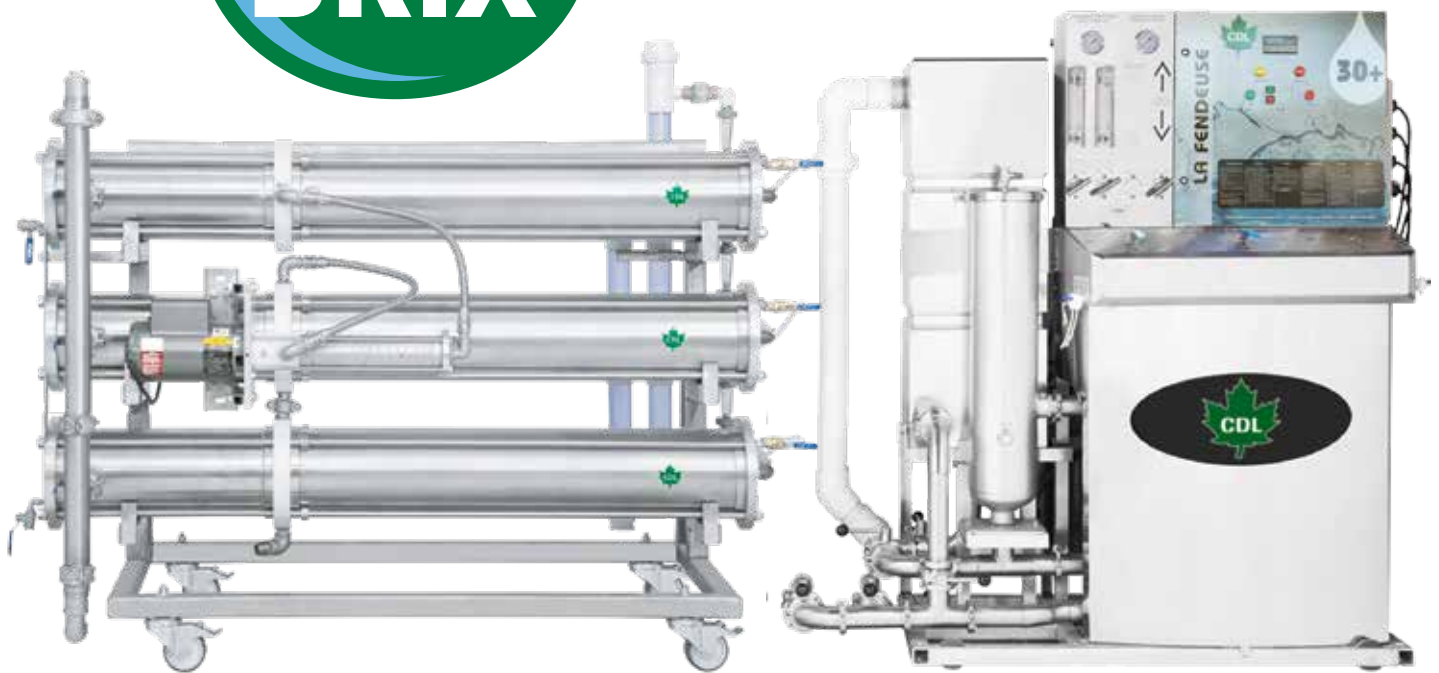

3 to 6 posts models available

CAPACITY

from 750 to 1500 GPH

PERFORMANCE







from 375 to 750 GPH
of concentration

REVERSE OSMOSIS ACCESSORIES

CLEANING AND STORAGE SOLUTIONS

	Citric acid 1 kg (powder) 66994	\$15.25
	Superflow soap 1 kg (powder) 6624909	\$21.45
	Superflow soap 20 kg (powder) 66239	\$255.00
	Organic soap "Superflow green" 4L (Liquid) 66245 <i>FOR ORGANIC CERTIFIED PRODUCERS</i>	\$38.40
	Organic membrane soap "Superflow green" 1 kg (powder) 662403 <i>FOR ORGANIC CERTIFIED PRODUCERS</i>	\$18.90
	Organic soap "Superflow green" 22.7 kg (powder) 662402 <i>FOR ORGANIC CERTIFIED PRODUCERS</i>	\$198.95
	Oxisan Cleaner 4 L 66298	\$50.95
	Storage solution 1 kg 80000	\$11.50
	Food grade glycol 20 L 88020	\$96.90

MEASURING INSTRUMENTS

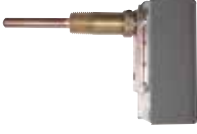
	pH 0-2,5 Papers 50/pkg 668802	\$18.20
	pH 10-13 Papers 50/pkg 668813	\$19.95
	Calibration solution pH 10 500 ml 718866	\$21.95
	Calibration solution pH 4 500 ml 718865	\$21.95
	PH tester 665514	\$92.35
	Portable conductivity tester 718856	\$108.00
	Heating element 3 000 W - 240 V 66493	\$48.35
	Temperature control 669371	\$165.00

Trust the CDL brand for cleaning and storage solutions

Quality. Efficiency.

REVERSE OSMOSIS ACCESSORIES

CONTINUOUS BRIX READER



Continuous Brix sensor with modulating valve 668418

This option allows you to precisely control the Brix level at the output of your reverse osmosis. The adjustment is done automatically even if the brix of the sap varies.



Continuous Brix reader 668417

ADVANTAGES

- Real time Brix reading of concentrate.
- Can be installed on any R.O.
- Allows an accurate reading of your adjustment in real-time.

Prices are available upon request

FILTERS



1 1/2" line filter + 24-micron cartridge 6615024	\$101.95
1 1/2" 24-micron filter cartridge only 660024	\$30.35
1 1/2" line filter only 6615024K	\$74.95
2" line filter + 24-micron cartridge 6620604	\$147.95
2" 24-micron filter cartridge only 660025	\$48.50
2" line filter only 6620604K	\$111.50



20" complete blue filter housing 665050 \$81.15

MULTIPLE CARTRIDGE HOUSING



Change your RO prefilters in 1 minute!

Extra cartridge support available for quicker changes.

Stainless steel multiple filtration cartridge housing (hold 5 pre-filters)	665056
Interior support only	665068

Prices are available upon request

ADVANTAGES

- Designed and manufactured by CDL
- Quick and easy filter changes
- High filtration capacity
- Creates no restrictions at the entrance of the RO

REVERSE OSMOSIS ACCESSORIES

STORAGE CANISTERS

	A	4" storage canister 724204	\$82.15
	B	8" storage canister 724225	\$265.00
		16" storage canister 724226	\$890.00

PREFILTERS

		Pre-filter cartridge 5 mic. 10" 6682101	\$3.85
		Pre-filter cartridge 5 mic. 20" 66821	\$4.35
		10" filter protectors 12/pkg 66212	\$19.35
		20" filter protectors 10/pkg 66209	\$21.40
		10" synthetic filter protectors 12/pkg 66207	\$6.05
		20" synthetic filter protectors 12/pkg 66208	\$10.15
		6½" plexiglass cover 66270	\$36.70
		10" filtration bag 6½"x16" EVBAG100	\$6.05
		20" filtration bag 6½"x32" EVBAG200	\$9.15
		30" filtration bag 6½"x30" 66823-30	\$11.75
		Nylon screen 36" x 36" NYLSCR	\$13.20

MRO MAX MEMBRANES

We offer the best membrane washing service!

Details in-store!

4" CDL MRO MAX membrane
6604040

8" CDL MRO MAX membrane
6608040

16" CDL MRO MAX membrane
6601640



Prices available upon request

> MRO technology

- Low-fouling Technology
- Stable performance
- Superior sugar and minerals retention
- Greater tolerance to high Ph
- Sustained performance at high brix concentration
- Better cross-flow circulation in concentrated liquids

OTHER

	Food grade o-ring grease 6 g 66531	\$3.40
	Food grade o-ring grease 150 g 66535	\$30.45
	Wrench for blue filter 662283	\$9.85
	10 GPM Bluewhite flowmeter 661042	\$135.00
	1/4" NPT valve X Tube 90° 6622312	\$17.85
	4" membrane U-cup 66402	\$9.95
	8" membrane U-cup 66401	\$16.50

WOOD EVAPORATORS

BOILING REQUIRES HARD WORK AND ENERGY, OUR EVAPORATORS NEED LESS OF IT!

Working with CDL quality equipment at this crucial step of maple sugaring brings many advantages!

HOBBY EVAPORATORS

The CDL Hobby Evaporator is designed for recreational producers who want to enjoy springtime, while boiling small quantities of maple sap to produce a few gallons of maple syrup per season.

18" X 48"
evaporator with
2-way flat pan 6700102WD
1 to 75 taps

18" X 48"
Evaporator with
18" x 36" flue pan and 6700102WP
18" x 12" syrup pan
50 to 125 taps

18" X 48" INCLUDES:

- Stainless steel furnace with steel grids.
- Stainless steel stack.
- 18" x 48" 304 stainless steel argo welded pan
- Stainless steel draw-off valve.

AVAILABLE OPTION:

- Pre-heating pan (code 67112WPARE).

18" x 60"
5" flue pan 67001
100 to 200 taps

18" X 60" INCLUDES:

- 18" x 42" flue pan
- 18" x 18" syrup pan
- Float box with rear control level.
- Complete smoke stack.

SYRUP FLOW NOW FULLY REVERSIBLE!

Prices are available upon request.
Product appearance may vary.



WOOD EVAPORATORS

PROFESSIONAL EVAPORATORS



**SYRUP FLOW NOW
FULLY REVERSIBLE!**

Prices are available upon request.
Product appearance may vary.

The Professional evaporator is a high quality wood evaporator for owners of small sugarbushes. It is designed and manufactured to provide efficient boiling and easy/stable syrup finishing. Its performance in relation to its size will surprise you.

20" X 84" 150 to 450 taps	24" X 72" 150 to 450 taps	2' X 8' 150 to 450 taps
6700103	6700302	6700502
20" x 54" 2-way flue pan 5" drop flues	2' x 4' 2-way flue pan 7" raised flues	2' x 5' 2-way flue pan 7" raised flues
Two 20" x 15" syrup pan	One 2' x 2' syrup pan	Two 24" x 18" syrup pan
Rear float box	Front and rear float box	Front and rear float box
9" x 8' stainless steel smokestack	9" x 8' stainless steel smokestack	10" x 12' stainless steel smokestack
Argon welded finishing pan		

THE TRADITIONAL EVAPORATORS

AVAILABLE IN SIZES: 2½' X 8' TO 5' X 16'

The Traditional CDL evaporator is designed for owners of medium and large sugarbushes wishing to keep the tradition alive of boiling the syrup with firewood while being effective and efficient. This evaporator will provide an incomparable boiling stability.

Its robust construction will allow many generations to experience the pleasure of boiling maple syrup.

INCLUDES:

- 32" high furnace with cast iron grates and 2 doors for wood loading.
- 1 flue pan with 7" argon welded flues.
- 2 to 3 argon welded syrup pans for finishing (depending on model)
- Front and rear float boxes.
- Stainless steel connections, drain valve and draw-off valve.
- Complete chimney (twice the length of the evaporator) including the stack.
- 1 rope operated stack cover.
- Water level on flue pan.



Prices are available upon request.
Product appearance may vary.

HIGH EFFICIENCY WOOD EVAPORATORS



The CDL energy efficient **Intens-O-Fire** wood evaporator is the only one on the market that allows the user to choose manually between two different types of firewood combustion: **air forced combustion** or **combustion by gasification**.

MAIN FEATURES

FUEL	WOOD (soft or hard)
SIZES	Available sizes : 2½' X 8' to 6' X 18'
CONSUMPTION	Wood consumption 40% less than a conventional evaporator
IDEAL FOR	Balance between performance and boiling stability

1 Meets the environmental requirements of greenhouse gas emissions

3 Winner of water gallons evaporated per hour - Maplerama 2011

6 Syrup pan

2 Load every 20 to 40 minutes depending on combustion type

4 Front and rear air distribution control for the combustion chamber and grates

7 Water level

5 Flow inverter (optional)

Interchangeable and reversible sap inlet and outlet



HIGH EFFICIENCY WOOD EVAPORATORS



The CDL **Chinook** Evaporator has an **automated air adjustment system** that allows a highly efficient, non-polluting combustion, even if the operator burns poor quality firewood with variable humidity.

MAIN FEATURES

FUEL	WOOD (soft or hard)
SIZES	Available sizes : 2½' X 8' to 6' X 18'
CONSUMPTION	0.24 medium quality wood cord (24") per barrel (32 G) of syrup (15 brix)
IDEAL FOR	Get up to 85% energy efficiency while benefiting from automation and ease of use.

- 1** Clean combustion, very little polluting emissions
- 2** Complete temperature control in the chimney (maximum 650°F).
- 3** Time between wood loading: 30 to 60 minutes, depending on quantity and wood quality

- 4** Very efficient, quick start-up and ignition
- 5** Boiling stability comparable to pellet and oil evaporators
- 6** Very quiet
- 7** Combustion creosote free

- 8** Very safe
- 9** Stable syrup draw-off
- 10** Syrup pan
- 11** Heat exchanger
- 12** Water level

Interchangeable and reversible sap inlet and outlet

OIL EVAPORATORS

DELUXE

CDL's **Deluxe** oil evaporator was designed for small and medium-sized sugarbush producers. This evaporator is very efficient and gives its owner an incomparably comfortable and stable boiling experience. This equipment is very reliable and very simple to operate. **To use it is to adopt it.**

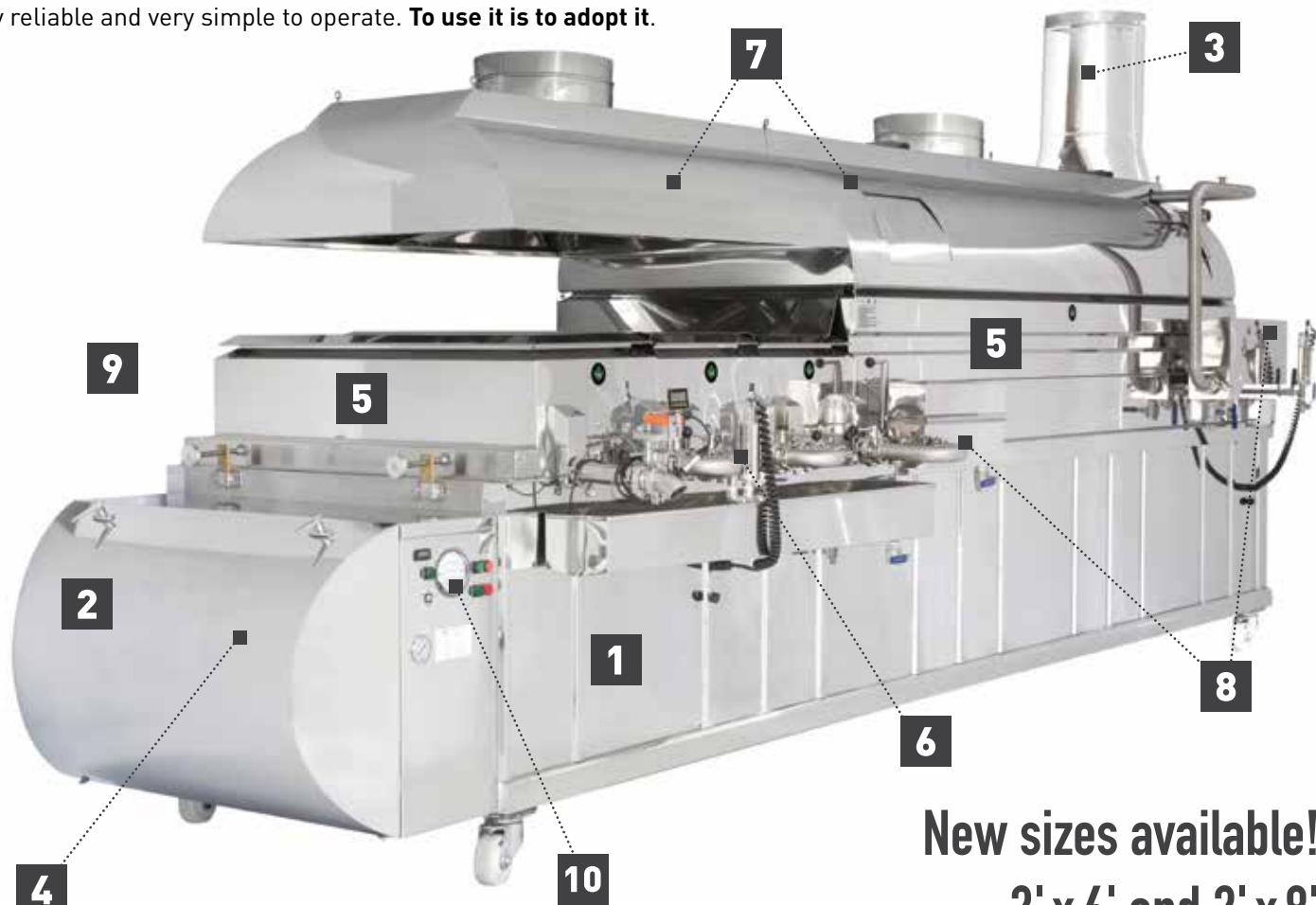

New sizes available!
2' x 6' and 2' x 8'

MAIN FEATURES	
FUEL	OIL, NATURAL GAS OR PROPANE
SIZES	Available in sizes : 2' X 6' to 6' X 18' (new!)
CONSUMPTION	Perfect for small and medium producers. Hassle-free boiling stability and easy operation.
AVAILABLE OPTIONS	Automatic draw-off valve. Syrup drip tray. Hood pre-heater. Permeate pre-filter. Steam pan. Protect-O Level controller protection
<ul style="list-style-type: none"> 1 Oil furnace 2 Carlin or Beckett burner 3 Complete stack with covers and roof jacks 4 Insulated burner cover. 	<ul style="list-style-type: none"> 5 Flue pan and syrup pans 6 Water level 7 Front and rear hoods
	<ul style="list-style-type: none"> 8 Front and rear float boxes 9 Adjustment and start-up by a CDL specialist 10 Control panel
Interchangeable and reversable sap inlet and outlet	



The CDL master oil evaporator is the most productive and has the **best energy efficiency on the market.**

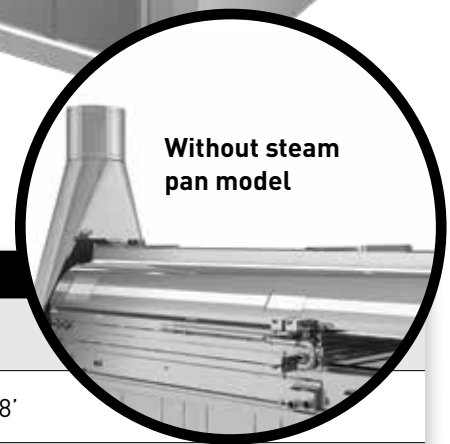

MAIN FEATURES	
FUEL	OIL
SIZES	3' X 11' to 7' X 18'
CONSUMPTION	0,195 gallons of oil per gallon of syrup
IDEAL FOR	Better energy and labor costs per barrel on the market

- 1** Front and rear flow reverser included
- 2** No mechanisms near the syrup pans, so no obstruction at the front for the operation of the evaporator.
- 3** Two-pass flue pan
- 4** New decanter box to reduce niter in the syrup pans. Included with all Master evaporators
- 5** Magnehelic oil pressure gauge
- 6** Steam pan (optional)
- 7** Available options and accessories on page 75

Interchangeable and reversable sap inlet and outlet

WOOD, CHIP OR PELLET EVAPORATORS



Wood model shown

The CDL **Master** Evaporator is the only evaporator on the market evaporating over:

6 U.S. gal. /ft² of pan.

New sizes available!

3' x 11', 3½' x 13', 4' x 13'

More accessible!



MAIN FEATURES

FUEL	WOOD, CHIP OR PELLETS
SIZES	3' X 11' to 7' X 18' (new!)
EFFICENCY	Ability to produce up to 3½ barrels/hour (18° brix), 6 barrels/hour (30° brix) with the 7' x 18' pellet model
IDEAL FOR	Performance and efficiency in high brix. Unmatched boiling flexibility (from 2 to 35 brix)

Interchangeable and reversible sap inlet and outlet

Master

WOOD, CHIP OR PELLET EVAPORATORS

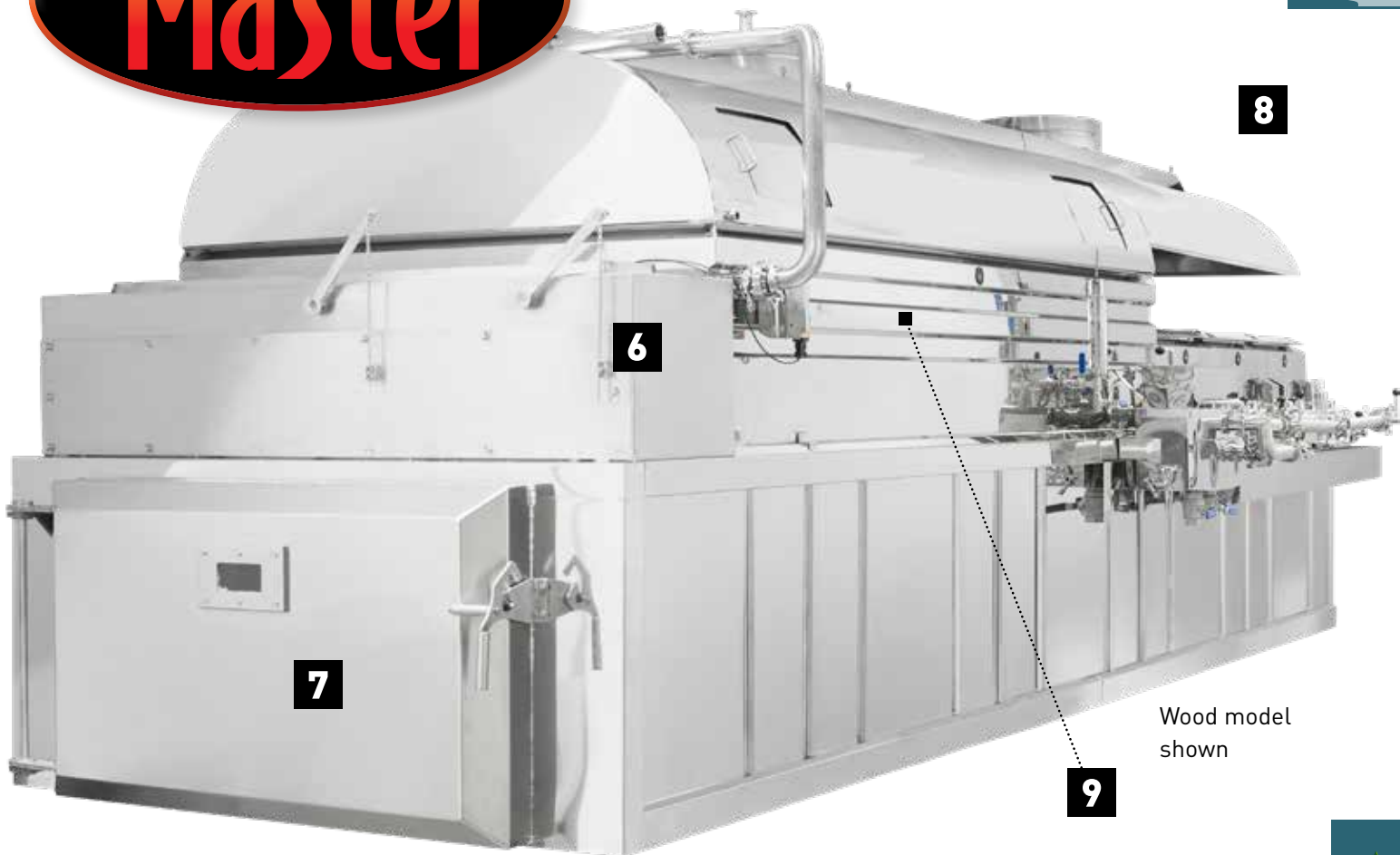

Wood model shown

- 1** Hood preheater
- 2** Flow inverter in the flue pan
- 3** No mechanisms near the syrup pans, so no obstruction at the front for the operation of the evaporator.
- 4** Drip tray (optional)
- 5** Multi-channel syrup pan. Pan change in 5 minutes without stopping the fire.
- 6** No sparks
- 7** Rear loading of fuel to eliminate dirt caused by wood in the boiler room.
- 8** Ease of use
- 9** Two-pass flue pan

Master + 30+^{RO}

Performance and operating costs to an unprecedented level in the industry.

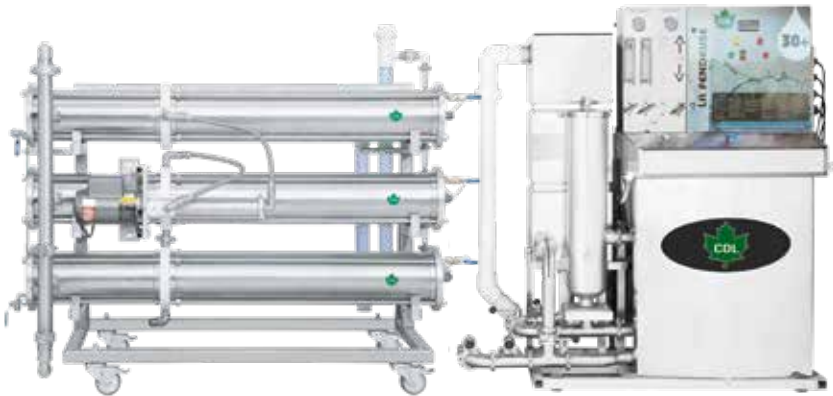

MASTER 30+ RO COMBO ADVANTAGES

- **Best energy + labor costs** per barrel on the market
- Decrease energy costs by at least 40%
- Complete range available allowing a production from **2 to 7.5 barrels per hour**
- Available for wood, pellets and oil
- Labor cost for boiling is reduced from 30 to 50%
- **Quick Return on Investment**
- Preserve the flavor and **authenticity of the syrup**
- **Decrease boiling time** significantly





by  CDL

UNIQUE TECHNOLOGY IN THE MAPLE SUGARING INDUSTRY



New high-tech, high-pressure and high-performance steam evaporation system

Optimal control of heating and evaporation intensity

Evaporation of sap, concentrate and maple syrup at

0 to 66 Brix



Unmatched evaporating power per square foot

- + NO PAN CHANGE NEEDED
- + NO RISK OF BURNING THE PANS
- + AVAILABLE: OIL, PROPANE, NATURAL GAS AND GAS COMBINATION
- + NO CERTIFICATION REQUIRED TO OPERATE 25HP, 35HP, 50HP AND 60HP SYSTEMS.
- + AUTOMATED CLEANING SYSTEM AVAILABLE

USEFUL FEATURES OF STEAM GENERATOR SYSTEM

BARREL CLEANING
MAPLE SYRUP WARMING
QUICK AND EFFICIENT COOKING
FOR PROCESSING



AUTOMATED PAN WASHER

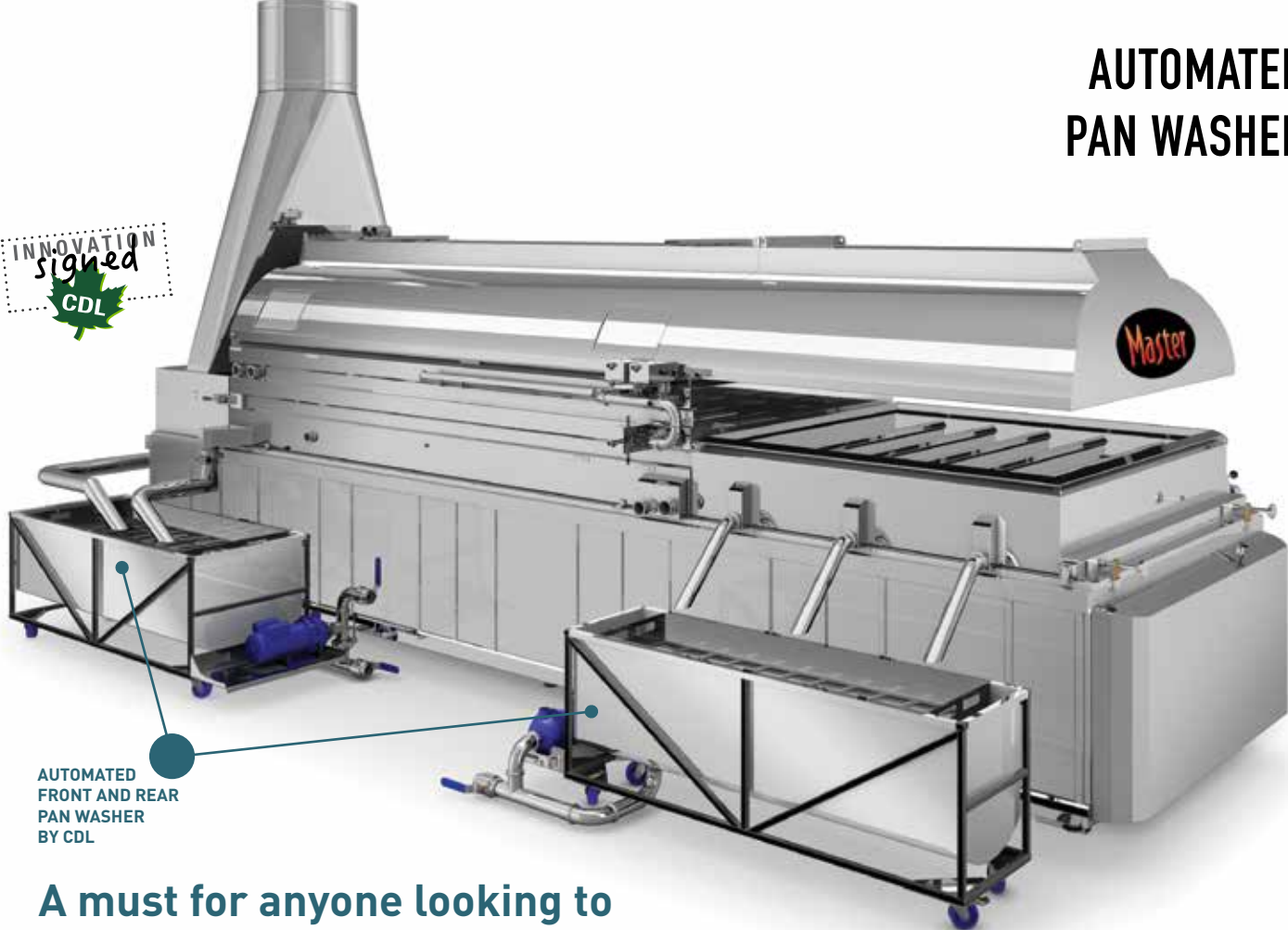

AUTOMATED FRONT AND REAR PAN WASHER BY CDL

A must for anyone looking to improve and simplify their operation.

- DELUXE
- InTens-O-FIRE
- Chinook
- Master

Available as an option for Deluxe, Intense-O-Fire, Chinook and Master evaporators models, the pan washer by CDL is completely automated and sequential.

With its complete non-contact wash and continuous washing circuit, it eliminates stubborn stains and greatly reduces the daily workload.



Rear view



EVAPORATOR ACCESSORIES

STEAM PAN

- > This option can be installed on all types of evaporators (wood, pellet, oil). Many standard sizes available.
- > The use of the steam pan causes a significant reduction in energy consumption by reusing the steam produced by the flue pan. This reduction in energy consumption can be up to 75% depending on the brix at the input of the pan.
- > In addition, adding this option to the evaporator increases the evaporation capacity!

Improve performance and efficiency by up to 75% without additional fuel consumption.



NEW SIZES AVAILABLE!
Now from 2' x 4' to 7' x 12'

STEAM PAN

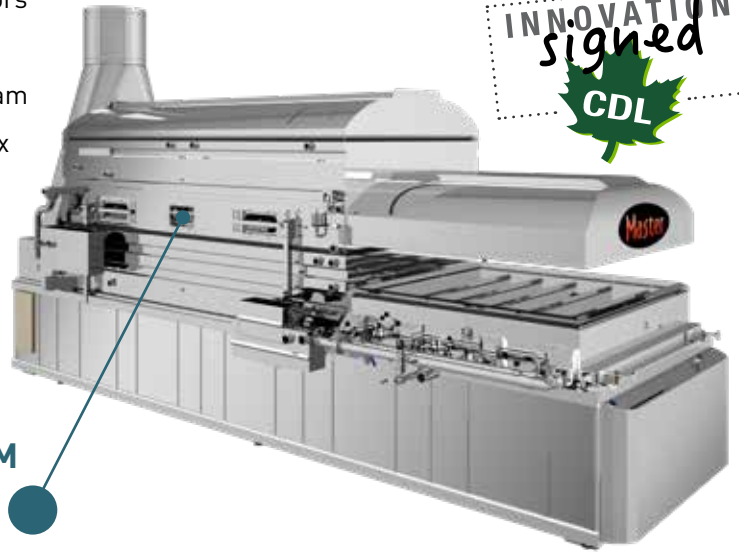

SYRUP PAN WASHERS

Triple syrup pan washer available.



Single 2½'	672059	Double 2½'	672110
Single 3'	672061	Double 3'	672112
Single 3½'	6720615	Double 3½'	6721125
Single 4'	672062	Double 4'	672114
Single 5'	672063	Double 5'	672116
Single 6'	672065	Double 6'	672118

Prices are available upon request

FLUE PAN LIFTER ON WHEELS



Easily move your flue pan for cleaning or access firebox for maintenance.

Flue pan lifter on wheels

671910

Prices are available upon request

EVAPORATOR ACCESSORIES

DRAW-OFF VALVES



INNOVATION
signed
CDL

Modulating draw-off valve multiple control 2" 66783

Modulating draw-off valve multiple control 2 1/2" 66784

Clips, silicone gasket and spout not included. Price upon request



ADVANTAGES

- Continuous maple syrup draw-off
- Eliminates the return effect of the syrup into the pans.
- Eliminates large volume draw-offs.
- Improves the constancy of brix.
- Easier maple syrup filtration

Modulating draw-off valve 1 1/2" 66781 \$995.00

Modulating draw-off valve 2" 66775 \$1395.00

Modulating draw-off valve 2 1/2" 66782 \$1525.00

Clips, silicone gasket and spout not included



LEVEL CONTROLLER (PROTECTION)

Protect-O 66876 \$315.00

DRAW-OFF VALVE ACCESSORIES



ELBOWS

1 1/2"	69BCD150	\$29.50
2"	69BCD112	\$29.95
2 1/2"	69BCD212	\$34.95



OFF CENTERED FERRULES

2" x 1 1/2"	60R14215	\$33.55
2 1/2" x 2"	60R142122	\$39.15



Accessories for modulating draw-off valve multiple control

661102 Thermo 14" temperature probe disconnect M12 Price upon request

661103 Wire disconnect 6.5' M12 thermo probe Price upon request

STACKS AND ACCESSORIES



Chinese hats
Available in diameters from 6" to 32" and optional spark guard



Smoke stacks
Available in diameters from 6" to 32"



Stack covers
Available in diameters from 7" to 30" and optional spark guard.



Roof jacks
From 6" to 32" with collar



Base stacks
Available for 2' to 6' width evaporators

EVAPORATOR ACCESSORIES

BOILING ACCESSORIES STAINLESS STEEL



DELUXE CUPS

8"	678489	\$40.95
10"	67847109	\$42.95
12"	67847129	\$44.95



STANDARDS CUPS

8"	6784789	\$25.95
10"	6784710	\$30.95



SMALL CUPS

8" (small)	67848901	\$23.95
------------	----------	---------



DIPPERS

Small	678019	\$70.50
Medium	678029	\$71.50
Large	67802059	\$72.50



DIPPERS | FLAT-SIDED

Small	67802119	\$81.50
Medium	67802129	\$83.50
Large	67802109	\$85.50



SKIMMERS

Without holes	6772922007	\$68.50
With holes	67729220069	\$70.50



DEFOAMER SUPPORT

Small	67ANTIMOUP	\$11.50
Large	67ANTIMOUG	\$14.50



LIQUID DEFOAMER SUPPORT

9 oz	6700009	\$153.00
16 oz	6700016	\$265.00



FUNNELS

Small	66811	\$57.50
Large	6681102	\$61.50



FUNNELS

1" X 3/8"	FUNMIN	\$9.50
5 1/2" x 9/16"	FUNSMMA	\$13.75



PLASTIC FUNNELS

Plastic funnel set (3)	FUNPLA	\$4.60
------------------------	--------	--------



FILLING CONTAINERS

2L stainless steel with handle	MEACSL	\$34.50
--------------------------------	--------	---------



4 L with handle (measuring)	MEACU4	\$28.50
-----------------------------	--------	---------



PADDLES

42"	674242	\$81.50
-----	--------	---------

Other sizes available

EVAPORATOR ACCESSORIES

SUGAR PANS



Valve and cover not included



16" x 16" x 12"	67WP1616	\$270.00
16" x 32" x 12"	67WP1632	\$310.00
16" x 16" cover	67WPC016	\$57.25
16" x 32" cover	67WPC032	\$75.50

24" x 36" x 12"	67WP2436	\$415.00
24" x 48" x 12"	67WP2448	\$435.00
24" x 72" x 12"	67WP2472	\$505.00

WATER JACKETED PANS



Valve not included

Water jacketed pan for sugar pan that can be used for the bottling kit beginning at page 89.

16" x 16"	67316M
16" x 32"	MINS32

Prices are available upon request

SYRUP FILTER TANKS



US gallons	Imp. gallons				
5,85 gallons (mini)	5 gallons (mini)	Diam. 9"	67MIN-FIL	\$280.00	
7,6 gallons	6,5 gallons	Diam. 9"	6740006	\$390.00	
10,25 gallons	12 gallons	Diam. 12"	6740026	\$450.00	
23,4 gallons	20 gallons	Diam. 16"	6740326	\$500.00	
30,4 gallons	26 gallons	Diam. 18"	6740426	\$605.00	
45,65 gallons	39 gallons	Diam. 22"	6740626	\$695.00	
53,8 gallons	46 gallons	Diam. 24"	6740726	\$735.00	

Prices include the stainless steel cover and drain valve. All syrup filter tanks are 28" high.

FILTER SUPPORTS



12"	1 hole	67412	\$120.00
16"	1 hole	674161	\$125.00
22"	3 holes	6742211	\$210.00
24"	3 holes	674243	\$220.00

GLASS TUBES FOR WATER LEVEL



5/8" x 8	60PEN58X6PLAGL	\$19.95
5/8" x 12	672176	\$22.95
5/8" x 18	60PEN58X18PLAGL	\$26.95
1 1/2" x 8	675157	\$27.95
1 1/2" x 18	60GROSNIVEAU18	\$39.95

BLUE PLUGS WITH LONG ARM



1 1/2"	678117112	\$34.95
2"	678117	\$39.50
2 1/2"	6781171	\$44.95

EVAPORATOR ACCESSORIES

RECTANGULAR SYRUP FILTER TANKS



A



B

Prices available upon request.

A	Triple Deluxe 120 US GAL. / 100 IMP. GAL	67865209
	Triple Standard 120 US GAL. / 100 IMP. GAL	67865208
B	Double 35 US GAL. / 29 IMP. GAL	666735
	Double 55 US GAL. / 45 IMP. GAL	666755
	Double 75 US GAL. / 62 IMP. GAL	666775

HIGH TEMPERATURE PRODUCTS

	Silicone 60YYCSL503	\$15.25		Fiber glass wool rope 60TXP018	\$0.97/ft
	Small brick 2 500 °F 1¼" X 4½" X 9" 66869	\$2.75		Ceramic wool 1' x 4' x 23.65' 8 lb 60BKT18LB100A	\$4.60/ft ² 100 ft ² /box
	Large brick 3 000 °F 2½" X 4½" X 9" 66868	\$4.60		Ceramic wool 1/2" x 4' x 50' 8 lb 60BKT18LB050A	\$3.30/ft ² 200 ft ² /box
	Brick cement Pyromix, 1 gallon 66866	\$34.65		Thermofab wool 2" x 1/8" 60GW300100	\$1.33/ft 100' roll
	Brick cement Pyromix, 4 gallons 668664	\$78.50		Ceramic wool panel 1" x 12" x 36" EBISOL06	\$20.35
	Dry cement, 25 Kg bag 66875	\$63.25			

MEASURING INSTRUMENTS

LIQUID DEFOAMER DOSING DEVICE



The most flexible and automatic liquid defoamer dosing device on the market.

Liquid defoamer dosing device

730400

Price upon request

DEFOAMERS



Kosher | 200 g
66890

\$7.50

Kosher | 2,5 kg
66898

\$69.95



Liquid | 8 oz.
EVAN108W

\$6.95

Liquid | 32 oz.
EVAM032W

\$23.95

Liquid | 4 L
EVAM128W

\$74.95

REFRACTOMETERS



SAP			
Sap ATAGO Brand	0-32 brix	6684001	\$399.00



SAP AND SYRUP			
Sap	0-32 brix	EIRE0032C	\$99.00
Syrup	45-82 brix	EIRS4582C	\$99.00



DIGITAL			
	0-85 brix	668412	\$595.00

COLORMETERS



Portable electronic French/English HANNA Brand	662379	\$425.00
--	--------	----------



Sample bottle only (1,75")	662378	\$0.46
----------------------------	--------	--------



Sample bottle (3,75") + cap	668888	\$0.65
Sample bottle (3,75")	668887	\$0.52
Cap only	668889	\$0.12

MEASURING INSTRUMENTS



HYDROMETERS SAP AND SYRUP

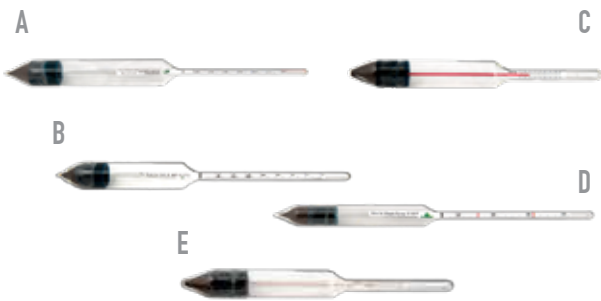

A	Sap	0-6 brix	EIDE2010	\$27.95
B	Sap	0-15 brix	668433	\$19.95
C	Sap	10-25 brix	66849	\$21.65
D	Syrup	45-75 brix <small>(Vermont state approved)</small>	EIDS4575	\$21.50
D	Syrup	55-70 brix	66845	\$16.95
E	Syrup	Hydrotherm	66841	\$30.95

DIAL THERMOMETERS

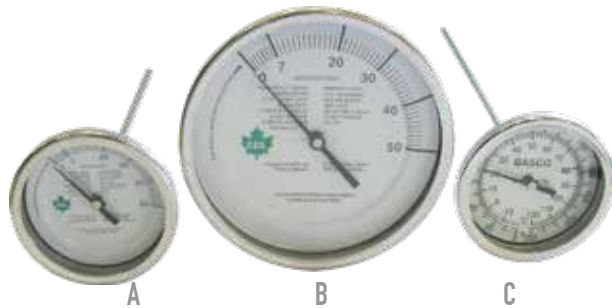

A	3" Dial 9" stem 0-50 °F ¼" MIPT	72920003	\$42.45
	3" Dial 12" stem 0-50 °F ¼" MIPT	72920004	\$50.95
B	5" Dial 9" stem 0-50 °F ¼" MIPT	72920001	\$49.95
	5" Dial 12" stem 0-50 °F ¼" MIPT	72920002	\$54.95
C	3" Dial 12" stem 0-250 °F ½" MIPT	668350	\$63.75
	3" Dial 6" stem 0-50 °F ¼" MIPT	EITC0306	\$40.75
	3" Dial 9" stem 50-300 °F ½" MIPT	EITC0309	\$45.75
	3" Dial 6" stem 0-250 °F ¼" MIPT	EITC0336	\$36.75
	3" Dial 9" stem 0-250 °F ¼" MIPT	EITC0330	\$42.45
	3" Dial 6" stem 200-1000 °F ½" For evaporator smoke stack	668210	\$55.20

OTHER THERMOMETERS



8" stem
71750425 \$34.95



With wooden handle
66836 \$79.95



12" | Stainless steel
71750426 \$19.95



6" barometer
72920030 \$210.00



Electronic | 18" probe
668204 \$395.00





Thermometer 3"
(hot water)
preheater
6408503SS \$31.95

CLEANING ACCESSORIES



BRUSHES FOR PANS AND TANKS

	2" x 7" without handle 663524	\$21.95		4" x 7" pan brush 72940050	\$39.50
	2" x 7" flue brush 663521	\$19.90		9" handle EVBRE001	\$7.50
	1/2" x 7" flue brush 66352	\$22.50		20" handle EVBRE003	\$10.95
				No handle round tank brush 66356	\$30.60

TUBING AND SPOUT SANITIZERS

		A Pure denatured, 4 L	667575
		B Chlorine 12 % 20 L	666000

PAN CLEANERS

			
		PAN ACID FOR STAINLESS STEEL	
A Sani-clean 4 L	66284	\$27.95	3 lb (powder) EVNSS300 \$20.50
A Sani-clean 20 L	66288	\$137.75	10 lb (powder) EVNSS010 \$61.25
			25 lb (powder) EVNSS250 \$147.95
B 99% Glacial acetic acid 20 L	667474	Price upon request	1 gallon (liquid) EVPAN40W \$20.50
			5 gallons (liquid) EVPAN5GW \$76.50

FILTER PRESSES

FILTER PRESSES WITHOUT PUMP AND CART



7" Press

10" Press



20" press 3 holes
Filtration capacity: 15 to 50 barrels

7" short press
3 hollow plates, 2 full plates 666070

7" standard press
6 hollow plates, 5 full plates 6660007

10" short press
3 hollow plates, 2 full plates 6660010C

10" standard press
6 hollow plates, 5 full plates 6660010

10" long press
7 hollow plates, 6 full plates 6660010L

20" press (max. 9 hollow plates)
7 hollow plates, 6 full plates 666217

**Individual additional plates,
available in 7", 10" and 20"**

ADVANTAGES

- Higher filtration capacity.
- Plate thickness: 2" for the 7" press, 2½" for the 10" press and 3" for the 20" press.
- Easier assembly of filter papers.

AVAILABLE OPTIONS:

- Brass gear pump 730016
- ½" diaphragm pump 730019
- 1" diaphragm pump 730020
- 7" and 10" filter press cart 66606

Prices are available upon request

FILTER PRESS PUMPS



Lead free ½"
Oberdorfer
pump



664000BRL



Interior view



Lead free ½"
Oberdorfer
pump repair
kit



664000BR1L



½" Diaphragm pump
(aluminum)

669585

1" Diaphragm pump
(aluminum)

669601

ELECTRICAL DIAPHRAGM PUMP KIT



**Quick and complete
installation on filter
press**

0.9A 120V 1PH pump
3.0 GPM at OPSI flow, 1.56GPM at 45 PSI flow
Maximal operation temperature : 170°F
Stainless steel 1/2" MNPT fittings
Installation frame/plate

Electrical diaphragm pump kit

730012

SELF-CLEANING FILTER PRESSES



INCLUDES:

- Support
- Drain Manifold with valves
- Pressure Gauges

Self-cleaning 10" press
7 hollow plates, 6 full plates

6660010A

NOT INCLUDED:

- Pump option
- Feed and drainage (washing water) plumbing

Caution

Requires the use of an air compressor and a good supply of water or permeate.



ADVANTAGES

- Technology that revolutionizes the cleaning operation of syrup press plates.
- De-sugaring and washing the plates without any syrup loss.
- Ultra fast and very efficient washing without removing the plates.
- Takes only **5 minutes** to wash the plates and repeat the filtration process
- Reduces the cost of using filter papers by **90%**.

Prices are available upon request

DRAW-OFF TANK WITH PRESS



Can be assembled with all pump models shown on the previous page. Mounting available on single tank (35 gallons) or double tank (2 x 35 gallons).

Multifunctional and very compact.

FILTER PRESSES

WESFAB FILTER PRESSES

We are very proud to now be the exclusive supplier of these high-performance filter presses designed and manufactured in the United States. These will now be distributed throughout North America through our distribution network.



A	7" manual press	WF07H	10" short press Gear pump (lead free) 3 hollow plates, 2 full plates	WF10C
	7" short press Gear pump (lead free) 3 hollow plates, 2 full plates	WF07C	10" short press 1/2" diaphragm pump 3 hollow plates, 2 full plates	WF10CD
	7" short press 1/2" diaphragm pump 3 hollow plates, 2 full plates	WF07CD2	10" standard press Gear pump (lead free) 8 hollow plates, 7 full plates	WF10
B	7" standard press Gear pump (lead free) 8 hollow plates, 7 full plates	WF07	10" standard press 1/2" diaphragm pump 8 hollow plates, 7 full plates	WF10D
	7" standard press 1/2" diaphragm pump 8 hollow plates, 7 full plates	WF07D2		



15" press 1" diaphragm pump 7 hollow plates, 6 full plates	WF15D1	7" Wesfab press cart	EVPFW101W
15" long press 1" diaphragm pump 10 hollow plates, 9 full plates	WF15D1L	10" Wesfab press cart	EVPFW301W



MADE IN USA











All gear pumps are lead free!



Prices are available upon request

FILTER PRESS ACCESSORIES

ACCESSORIES

	5¼" filter papers 66817	\$30.50 / pkg 200		Cone pre-filters 66206	\$15.75 / pkg 12
	7" filter papers 66828	\$58.25 / pkg 400		Flat pre-filter paper 24" x 24", woven style PREW24	\$2.75
	10" filter papers 66829	\$93.75 / pkg 400		Flat pre-filter paper 36" x 36", woven style PREW36	\$2.75
	15" filter paper 668015	\$0.93 / unit		36"x36" pre-filter paper coffee style PREC36	\$3.00
	20" filter paper 2 holes 668221	\$0.99 / unit		Cone pre-filter paper woven style PREWCO	\$1.65
	10" filter papers with wings 66801	\$98.95 / pkg 400		Cone pre-filter paper coffee style PRECCO	\$1.90
	20" filter paper 3 holes with wings 668224	\$1.35 / unit		Bucket filter FILBAG	\$25.75
	7" press felt filters 66827	\$27.50 / pkg 12		Bucket pre-filter PREWFI	\$4.20
	10" press felt filters 66830	\$29.95 / pkg 12		Sap filters 12" X 24" 66248	\$22.95 / pkg 2
	20" press felt filters 2 holes 66820	\$88.75 / pkg 7		Sap filters 24" X 24" 66210	\$28.95 / pkg 2
	20" press felt filter 2 double holes 668206	\$20.25 / unit		24" X 24" flat filter FILF24	\$13.75
	20" press felt filters 3 double holes 66850	\$117.95 / pkg 7		36" X 36" flat filter 5 mic. 66211	\$14.95
	Self-cleaning press felt filters 66852	\$40.75 /pkg 16		36" X 36" flat polyester filter 1 mic. 668164	\$25.50
	Polyester #8 felt cone 5 mic. 66814	\$14.25		545 Celite filter aid 10 lb 66825	Price upon request
	Polyester #8 felt cone 1 mic. 668163	\$13.25		545 Celite filter aid 50 lb 66826	Price upon request
	#5 cone filter FILCO5	\$17.85		Dicalite filter aid 50 lb 66838	Price upon request
	Food grade grease 66530	\$11.50			



BARRELS AND ACCESSORIES

STAINLESS STEEL BARRELS



15,7 US gallons
66819

40 US gallons
66816

55 US gallons
668161

Prices are available upon request

Easily stackable barrels

Upper cord curved to the inside

ADVANTAGES

- All lower joints completely welded.
- Designed for the complete drainage of syrup or washing water.
- Drip hole on top; No hole on the side.

- Edges with pronounced curves facilitating the handling of the barrels.
- Same dimensions as conventional galvanized barrels.

- Stackable.

BARREL CAPS



2" stainless steel cap

BUNGSS

\$17.30



2" plastic cap
(Can be used with bag 663332)
660057

\$1.50



2" plastic cap for barrels
(Large thread / hole 3/4" NPT in center)
BUNG06

\$1.50

HANDLING ACCESSORIES FOR BARRELS



3-wheel stainless steel cart
676055S \$530.00



Stainless steel lever
671092 \$80.00



Barrel trolley
DRUROC \$205.00



Barrel lifter with pulley and cord
665045 \$382.95

BARREL ACCESSORIES



Stainless steel barrel sampler
67ECHBA \$50.95



Stainless steel health barrel key
662285 \$21.95



32-gallon plastic bag
663332 \$9.15



Barrel wrench
BARWRE \$71.50



Stainless steel plastic bag holder
678952 \$35.75



Barrel wrench
662282 \$50.95

PUMP AND BARREL TRANSFER (REVISED DESIGN)



Pneumatic stainless steel barrel pump DRUPUM \$210.00

ADVANTAGES

- Allows you to empty a barrel of syrup faster
- Quicker than a pump

- Empty barrels of syrup without making a mess
- Very easy to use



A 1" Teflon barrel transfer 6150P1 \$198.95

B 5/8" Teflon barrel transfer 6150P58 \$198.95

PROCESSING EQUIPMENT

MAPLE CREAM MACHINES



Maple cream machine 8 L 110 V	Brass pump	668828
Maple cream machine 16 L 220 V	Brass pump	668827
Maple cream machine 8L 110 V	Stainless steel pump	668828S
Maple cream machine 16L 220 V	Stainless steel pump	668827S

MAPLE SUGAR MACHINES



Single:
Capacity of 17 lb.



Double:
Capacity of 35 lb.

8" automatic maple sugar machine	668855A
8" double automatic maple sugar machine	668856A

ADVANTAGES

- Fully automated
- Uniform granulation
- Can function without supervision
- Available without automation if requested
- Made of stainless steel
- 3 in 1: mixer, grinder and dryer
- Self-cleaning with hot water

WATER JACKETED TANKS



Stainless steel

Electric water jacketed tank
35 gallons
67422

Bottling stand
with pedal
35 gallons
67220-S



Stainless steel

Electric water jacketed tank
12 gallons
67422-M

Bottling stand
with lever
12 gallons
67220-MS



3/8"
bottling valve
67215

5/8"
bottling valve
67216

Prices are available upon request

OTHER



Candy machine
(motor included)
ECB0100A \$1 835.00



Auger and pan
ECBMW301 \$405.00



Extra pan
ECBMP101 \$440.00

Motor 1/4 hp
660002 Price upon request



Propane burner
R-65
66803 \$85.50



Electric bottling valve
Includes 3 stainless steel
tips: 1/4", 3/8", 1/2"
67217 \$505.00



Bottling nozzle for water
jacketed tank
3/8" elbow x 3/4" mipt
67BM12 \$17.25



Bottling valve
1/2", 90°
ECDVP805 \$32.45

Bottling valve
3/8", 90°
ECDVP804 \$39.45



Pump dispenser
DISPEN \$7.25



Coffee pot style
spout + gasket
COFSP0 \$20.50



Bottle/container washer
BOTWAS \$26.00



Bottling nozzle for
water jacketed tank
1/2" elbow x 1/2" mipt
6788991B2 \$16.25

**AVAILABLE
IN 2019!**

CDL JUG

NEW!

Collection



Exclusive and modern design!



Patent pending

Durable and compact, the new CDL jugs were designed for the reality of today's maple syrup producers. Discover this new collection, which features a modern and vibrant look while respecting the classic side of this great tradition.

Customize it!

- | | |
|---------------|---------------|
| All States | Michigan |
| Vermont | Indiana |
| New York | Ohio |
| New Hampshire | West Virginia |
| Maine | Massachusetts |
| Wisconsin | Pennsylvania |



Upcoming sizes

- 1 Gallon - Half gallon - Quart gallon
- 1 Pint - Half pint - 3.4 Oz

CANS ENGLISH LITHOGRAPH



1/2 pint	65 / case	CAN008
Pint	35 / case	CAN016
Quart	24 / case	CAN032

Maple cookies

60 servings - 91 cal

Ingredients

- 1 cup of butter, softened
- 1 cup of packed brown sugar
- 1 egg
- 1 cup of maple syrup**
- 1 teaspoon vanilla extract
- 2 teaspoons of baking soda
- 1/2 teaspoon salt
- 4 cups of all-purpose flour
- 1/3 cup of granulated maple sugar**

<https://www.allrecipes.com/recipe/9773/maple-cookies/>

Preheat oven to 350 degrees F (175 degrees C).
Grease cookie sheets.

In a large bowl, cream the butter and brown sugar. Add the egg, syrup and vanilla. Mix until well blended. Sift together the flour, salt and baking soda. Stir into mixture until well blended. Shape into 1 inch balls and roll in sugar. Place on cookie sheets about 2 inches apart and flatten slightly.

Bake 8 to 10 minutes in the preheated oven. Let cool on wire rack.



BOTTLES AND PACKAGING

*** PRODUCT AVAILABLE
IN LIMITED QUANTITY**

MODERN AND MAPLE LEAF

CAPS NOT INCLUDED



	SIZE	PRODUCT CODE	QTY/BOX	PRICE	CAP CODE
A	MODERN				
	50 ml	EXBV0050M	50	\$1.11	661378 (GOLD)
	100 ml	EXBV0100M	36	\$1.16	661374 (GOLD)
	250 ml	EXBV0250M	12	\$1.93	661374 (GOLD)
	500 ml	EXBV0500M	12	\$2.65	661388 (GOLD)
B	MAPLE LEAF				
	50 ml	EXBV0050AU	48	\$1.36	661378 (GOLD) CAPK25 (BROWN)
	100 ml	EXBV0100AU	12	\$2.81	661374 (GOLD) CAPK25 (BROWN)
	250 ml	EXBV0250AU	12	\$3.28	661374 (GOLD)
	500 ml	EXBV0500AU	12	\$4.42	661388 (GOLD) CAP500 (BROWN)
	750 ml	EXBV0750AU	6	\$6.79	661388 (GOLD) CAP500 (BROWN)

GALLONE

CAPS NOT INCLUDED



	SIZE	PRODUCT CODE	QTY/BOX	PRICE	CAP CODE
A	GALLONE				
	40 ml	EXBVRH50	48	\$0.62	661378 (GOLD)
	100 ml	BOTH01*	24	\$1.29	661377 (BLACK)
	250 ml	EXBVRH250	12	\$1.60	661377 (BLACK) 661390 (BROWN)
	500 ml	EXBVRH500	12	\$1.84	661377 (BLACK) 661390 (BROWN)
	1 L	EXBVRH1000	6	\$2.89	661377 (BLACK)
	½ gal.	EXBVRH2000	6	\$2.59	661391 (BROWN) 661381 (WHITE)
	1 gal.	EXBVRH4000	4	\$3.94	661391 (BROWN) 661381 (WHITE)
B	250 ml	EXBV0250GL	20	\$1.41	661376 (WHITE) CAP500 (BROWN)
	500 ml	EXBVRH500M	12	\$1.84	CAP500 (BROWN)

FLAT

CAPS NOT INCLUDED



	SIZE	PRODUCT CODE	QTY/BOX	PRICE	CAP CODE
A	FLAT				
	250 ml	EXBV0250L	12	\$0.84	661376 (WHITE) 661384 (BROWN)
	375 ml	EXBV0375	12	\$1.15	661376 (WHITE) 661384 (BROWN)
	500 ml	EXBV0500	12	\$1.22	661376 (WHITE) 661384 (BROWN)
B	8 oz	EXBV0252	12	\$0.84	661376 (WHITE) 661384 (BROWN)
	12 oz	EXBV0377	12	\$1.05	661376 (WHITE) 661384 (BROWN)

GINGER BREAD AND FLASK

CAPS NOT INCLUDED



	SIZE	PRODUCT CODE	QTY/BOX	PRICE	CAP CODE
A	GINGER BREAD				
	250 ml	EXBV0250PE*	12	\$2.58	661374 (GOLD)
B	100 ml	EXBV0100PEEV*	24	\$1.50	661374 (GOLD)
	250 ml	EXBV0250PEEV*	12	\$2.58	661374 (GOLD)
C	FLASK				
	200 ml	BOTHF2	12	\$1.05	661384 (BROWN) CAP500 (BROWN)

Very competitive skid pricing.
Call your local CDL store for details.

PRODUCT AVAILABLE *
IN LIMITED QUANTITY

BOTTLES AND PACKAGING

NEW ARRIVAL CAPS NOT INCLUDED

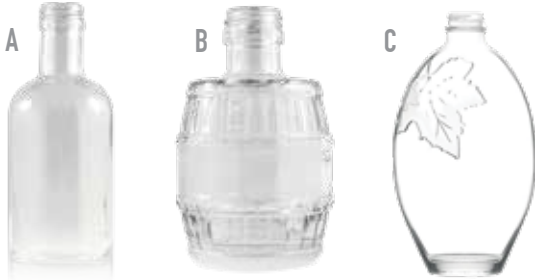

	SIZE	PRODUCT CODE	PRICE	CAP CODE
A	250 ml	EXBV0250POLO	\$1,67	661376 (WHITE) 661388 (GOLD) CAPKB5 (BLACK) 661384 (BROWN)
	50 ml (70/cs) Product may differ from photo	EXBV0050BA	\$1,39	661378 (GOLD) CAP05B (BLACK)
	100 ml (12/cs) Product may differ from photo	EXBV0100BA	\$2,16	661374 (GOLD) CAPK25 (BROWN)
C	200 ml (12/cs)	EXBV0200BA	\$2,49	661376 (WHITE) 661384 (BROWN) 661388 (GOLD) CAPKB5 (BLACK)
	100 ml (12/cs)	EXBV0100TA*	\$3,10	661376 (WHITE) 661375 (BLACK) 661384 (BROWN)

DECANTER ET ROYAL CAPS NOT INCLUDED



	SIZE	PRODUCT CODE	QTY/BOX	PRICE	CAP CODE
A	DECANTER				
	16 oz	EXBV016	12	\$0.85	661381 (WHITE)
	32 oz	EXBV032	12	\$1.67	661381 (WHITE)
B	ROYAL				
	50 ml	BOTR50*	48	\$0.83	CAPK25 (BROWN)

GRAND LINE ET SAUCE CAPS NOT INCLUDED



	SIZE	PRODUCT CODE	QTY/BOX	PRICE	CAP CODE
A	GRAND LINE				
	1 L	EXBV1000G	12	\$1.20	661376 (WHITE) 661384 (BROWN) 661384 (BROWN)
	SAUCE				
B	250 ml	BOTSH2*	12	\$1.33	728445 (METAL)
C	350 ml	EXBV0350S	12	\$0.59	728438 (METAL)

WHISKY ET RELIEF CAPS NOT INCLUDED



	SIZE	PRODUCT CODE	QTY/BOX	PRICE	CAP CODE
A	WHISKY				
	50 ml	BOTW5018SC	96	\$0.59	CAP05B (BLACK)
	1 L	EXBV1000S	12	\$1.29	661384 (BROWN)
B	200 ml	EXBV200M*	12	\$1.38	661376 (WHITE) 661384 (BROWN)

CAPS



WHITE PLASTIC CAPS		
24 x 400 mm	661387	\$0.12
28 x 400 mm	661376	\$0.12
38 x 400 mm	661381	\$0.12



BROWN PLASTIC CAPS		
24 x 400 mm	CAPK25	\$0.12
28 x 400 mm	661384	\$0.10
31.5 x 400 mm	661390	\$0.15
38 x 400 mm	661391	\$0.11
28 x 410 mm	CAP500	\$0.15



METAL LIDS		
38 mm	728438	\$0.10
43 mm	728445	\$0.14



GOLD PLASTIC CAPS / TAMPER EVIDENT		
18 x 400 mm	661378	\$0.17
24 x 400 mm	661374	\$0.18
28 x 400 mm	661388	\$0.20



BLACK PLASTIC CAPS		
18 x 400 mm	CAP05B	\$0.12
28 x 400 mm	CAPKB5	\$0.16
31,5 x 400 mm	661377	\$0.19



PLASTIC CAPS / TAMPER EVIDENT		
(WHITE)	28 x 400 mm	661382 \$0.12
(GOLD)	28 x 400 mm	661385 \$0.18
(BROWN)	28 x 400 mm	661386 \$0.10



95

BOTTLES AND PACKAGING

BASQUAISES



SIZE	PRODUCT CODE	QTY/BOX	PRICE	CAP CODE
250 ml	EXBV0250B	12	\$1.32	661376 (WHITE) 661384 (BROWN)
500 ml	EXBV0500B	12	\$2.89	661377 (BLACK)

BASQUAISE SNOWMAN



SIZE	PRODUCT CODE	QTY/BOX	PRICE	CAP CODE
250 ml	EXBV0250BSM	12	\$4.16	661376 (WHITE) 661384 (BROWN)

BASQUAISE 4 SUGARING SCENES



SIZE	PRODUCT CODE	QTY/BOX	PRICE	CAP CODE
250 ml	EXBV0250BI	12	\$4.16	661376 (WHITE) 661384 (BROWN)

BASQUAISE 4 CHRISTMAS SCENES



SIZE	PRODUCT CODE	QTY/BOX	PRICE	CAP CODE
250 ml	EXBV0250BC	12	\$4.16	661376 (WHITE) 661384 (BROWN)

Very competitive skid pricing.
Call your local CDL store for details.

PRODUCT AVAILABLE
IN LIMITED QUANTITY *

BOTTLES AND PACKAGING

BASQUAISES ANIMALS

A



B



C



D



SIZE

PRODUCT CODE

QTY/BOX

PRICE

CAP CODE

MOOSE

A	250 ml	EXBV0250BPMOOSE	12	\$4.16	661376 (WHITE) 661384 (BROWN)
---	--------	-----------------	----	--------	----------------------------------

WOLF

B	250 ml	EXBV0250BPWOLF*	12	\$3.95	661376 (WHITE) 661384 (BROWN)
---	--------	-----------------	----	--------	----------------------------------

DEER

C	250 ml	EXBV0250BPDEER	12	\$4.16	661376 (WHITE) 661384 (BROWN)
---	--------	----------------	----	--------	----------------------------------

BLUE JAY

D	250 ml	EXBV0250BPJAY*	12	\$3.95	661376 (WHITE) 661384 (BROWN)
---	--------	----------------	----	--------	----------------------------------

Very competitive skid pricing. Call your local CDL store for details.

PLASTIC CAPS SUITABLE FOR BASQUAISE BOTTLES

WHITE PLASTIC CAPS



28 x 400 mm 661376 \$0.12

BROWN PLASTIC CAPS



24 x 400 mm	CAPK25	\$0.12
28 x 400 mm	661384	\$0.10
28 x 410 mm	CAP500	\$0.15
31.5 x 400 mm	661390	\$0.15

BLACK PLASTIC CAPS



28 x 400 mm CAPKB5 \$0.16

GOLD PLASTIC CAPS



24 x 400 mm 661374 \$0.18

HEAT SHRINK CAPS FOR GLASS BOTTLES



28 mm,
100/box EXCAP0286* \$14.85

GOLD CAPS FOR GLASS BOTTLES



30,5 x 42 mm, 100/box	EXCAP210	\$8.95
34 x 52 mm, 100/box	EXCAP310	\$10.75



97

BOTTLES AND PACKAGING

HEXAGONAL JARS

LIDS NOT INCLUDED



SIZE	PRODUCT CODE	QTY/BOX	PRICE	CAP CODE
45 ml	EXPOH045-24	24	\$0,42	728445
110 ml	EXPOH110-12	12	\$0,65	72843000
190 ml	EXPOH190-12	12	\$0,85	788490
270 ml	EXPOH270-12	12	\$1,05	788470

SHORT ROUND JARS

LIDS NOT INCLUDED



SIZE	PRODUCT CODE	QTY/BOX	PRICE	CAP CODE
30 ml	BOTM30*	160	\$0,44	728445
40 ml	EXPO40	24	\$0,56	728445
55 ml	BOTM02*	96	\$0,57	72843000
125 ml	EXPO125	12	\$0,56	72843000
250 ml	EXPO250	12	\$0,62	728470
375 ml	BOTS37	12	\$0,96	728470
750 ml	BOTS75	12	\$1,09	CAPG82

LONG ROUND JARS

LIDS NOT INCLUDED



SIZE	PRODUCT CODE	QTY/BOX	PRICE	CAP CODE
250 ml	BOTT25	12	\$0,79	CAPG53
375 ml	BOTT37	12	\$0,66	788490
500 ml	BOTT50	12	\$0,68	788470
750 ml	BOTT75	12	\$1,05	728470

EMBOSSED HONEY JAR

LIDS NOT INCLUDED



SIZE	PRODUCT CODE	QTY/BOX	PRICE	CAP CODE
380 ml	BOT380	12	\$0,96	CAPHC7, CAPWF7, CAPPC7, 728470
780 ml	BOT780	12	\$1,22	CAPHC8, CAPWF8, CAPPC8, CAPG82

Very competitive skid pricing.
Call your local CDL store for details.

METAL LIDS



38 mm	728438	\$0,10
43 mm	728445	\$0,14
48 mm	72843000	\$0,13
53 mm	CAPG53	\$0,19
58 mm	788490	\$0,16
63 mm	788470	\$0,18
70 mm	728470	\$0,19
82 mm	CAPG82	\$0,29



A	70 mm	CAPHC7	\$0.25
A	82 mm	CAPHC8	\$0.29
B	70 mm	CAPWF7	\$0.29
B	82 mm	CAPWF8	\$0.33
C	70 mm	CAPPC7	\$0.32
C	82 mm	CAPPC8	\$0.37

SAMPLE JARS



30 ml jars	EICOL016	\$0.94
Cap only	EXBSCAP16	\$0.13

BOTTLES AND PACKAGING

PLASTIC JUGS

CAPS INCLUDED



Caps included

SIZE	PRODUCT CODE	QTY/BOX	PRICE PER UNIT	PRICE PER UNIT SOLD BY CASE
1.36 oz	EXCR0041*	100	\$1.02	\$0.89
3.4 oz	EXCR0101*	100	\$1.13	\$0.97
1/2 pint	EXCR0261*	100	\$1.26	\$1.09
1 pint	EXCR0501*	100	\$1.41	\$1.13
1 quart	EXCR1001*	100	\$1.71	\$1.37
1/2 gallon	EXCR2001*	50	\$2.09	\$1.79
1 gallon	EXCR4001*	24	\$2.87	\$2.34

For specific states, replace the * by:

U for All States	MI for Michigan
V for Vermont	P for Pennsylvania
N for New York	IN for Indiana
NH for New Hampshire	WV for West Virginia
ME for Maine	MA for Massachusetts
WI for Wisconsin	OH for Ohio

Very competitive skid pricing.
Call your local CDL store for details.

EXTRA JUG CAPS



BROWN PLASTIC CAPS FOR JUGS

100 ml cap for jugs	6628401	\$0.20
250 ml to 4 L cap for jugs	6628400	\$0.23



99

BOTTLES AND PACKAGING

PLASTIC BOTTLES

Caps included

A



B



C



D



E



F



G



E



	DESCRIPTION	SIZE	PRODUCT CODE	QTY/BOX	PRICE PER UNIT
A	Oxygen barrier bottle	375 ml	660375	200	\$0.82
B	Oxygen barrier bottle	500 ml	661500	150	\$0.90
C	Oxygen barrier bottle	1 L	661000	90	\$1.28
D	Oxygen barrier bottle	2 L	660020	6	\$2.55
E	Oxygen barrier bottle	4 L	660400	40	\$4.08
F	Freezer jug	4 L	EXSH4P	25	\$1.41
G	Plastic jug	10 L	JUG210	1	\$5.89
E	Five gallon blue container	18.9 L	EXBPL005	1	\$14.25

EXTRA CAPS FOR OXYGEN BARRIER BOTTLES AND FREEZER JUG



A



B

	DESCRIPTION	SIZE	PRODUCT CODE	PRICE PER UNIT
A	Bottle cap 375 ml, 500 ml	-	661375	\$0.20
B	Bottle cap 1 L, 2 L, 4 L	53 x 400 mm	661380	\$0.23
	Freezer jug cap	38 x 400 mm	661381	\$0.12
	Cap for JUG210	-	CAP10L	\$0.25
	Cap for container EXBPL005	-	EXCANC15	\$2.15

CARDBOARD BOXES FOR PLASTIC BOTTLES



	DESCRIPTION	SIZE	PRODUCT CODE	PRICE PER UNIT
	Cardboard box with handle	8 x 375 ml	668375	\$0.71
	Cardboard box with handle	8 x 500 ml	664350	\$0.94
	Cardboard box	12 x 375 ml	612375	\$0.93



100

PRODUCT AVAILABLE
IN LIMITED QUANTITY *

BOTTLES AND PACKAGING

SUGAR CONTAINERS



Lid
included

High definition printing
and **superior quality**

With security seal



DESCRIPTION	PRODUCT CODE	PRICE
250 g Lock container, Maple taffy, 500/box	60256	\$0.52/ea
250 g Lock container, Maple cream, 500/box	60255	\$0.52/ea

BOTTLES AND PACKAGING

PLASTIC CONTAINERS



250 g container
500/box
60250

\$0.51/ea



500 g container
500/box
62500

\$0.67/ea



250 g organic container
500/box
Organic certificate required
60250B

\$0.53/ea



300 g Surlock container
350/box
622514*

\$0.50/ea



300 g square container
Clear
700/box
60251

\$0.53/ea



250 ml colonial container
100/box
U.S.A Only
EXCUL251U

\$1.15/ea



500 ml colonial container
100/box
U.S.A Only
EXCUL501U

\$1.40/ea



Beige plastic container
for maple cream
250 g, 100/box
TUBB25

\$1.50/ea



Beige plastic container for
maple cream
500 g, 100/box
TUBB50

\$1.75/ea

Clear plastic container
(Lid not included)
100g P325 | 250/pkg
6603905

\$12.95

Clear plastic lid for P325 |
125/pkg
6603906

\$4.95



DESCRIPTION

PRODUCT CODE

PRICE

4 oz. granulated sugar container

EXPLSUG4

\$0.79

8 oz. granulated sugar container

EXPLSUG8

\$0.99

BOTTLES AND PACKAGING

SELF-ADHESIVE LABELS



DESCRIPTION	CONTAINS	PRODUCT CODE	QTY/PKG	PRICE
Pure maple syrup	250 ml	EXLA0250	100	\$11.50
Pure maple syrup	375 ml	EXLA0375	100	\$11.50
Pure maple syrup	Small	660201P	100	\$11.50
Pure maple syrup	500 ml	EXLA0500	100	\$12.99
Pure maple syrup	Large	EXLA0500P	100	\$12.99

SYRUP GRADING SELF-ADHESIVE LABELS



DESCRIPTION	PRODUCT CODE	QTY/PKG	PRICE/PKG
Vermont Quality	EXECVT01	1000	\$7.00



Vermont Golden	EXLAVTG	1000	\$7.25
Vermont Amber	EXLAVTA	1000	\$7.25
Vermont Dark	EXLAVTD	1000	\$7.25
Vermont Very dark	EXLAVTV	1000	\$7.25



New York Golden	EXLANYG	1000	\$7.25
New York Amber	EXLANYA	1000	\$7.25
New York Dark	EXLANYD	1000	\$7.25
New York Very Dark	EXLANYVD	1000	\$7.25



Maine Golden	EXLAMEG	1000	\$7.25
Maine Amber	EXLAMEA	1000	\$7.25
Maine Dark	EXLAMED	1000	\$7.25
Maine Very Dark	EXLAMEV	1000	\$7.25



NH Golden	EXLANHG	1000	\$7.25
NH Amber	EXLANHA	1000	\$7.25
NH Dark	EXLANHD	1000	\$7.25
NH Very Dark	EXLANHVD	1000	\$7.25



US Golden	EXLAUSG	1000	\$7.25
US Amber	EXLAUSA	1000	\$7.25
US Dark	EXLAUSD	1000	\$7.25
US Very Dark	EXLAUSV	1000	\$7.25

BOTTLES AND PACKAGING

HANG TAGS AND ELASTICS



	DESCRIPTION	PRODUCT CODE	QTY/PKG	PRICE/PKG
A	Hang tag	HANTAG	100	\$25.20
B	50 ml Hang tag	EXEC0050	250	\$19.99
	200 ml Hang tag	EXEC0200	250	\$19.99
	250 ml Hang tag	EXEC0250	250	\$19.99
	500 ml Hang tag	EXEC0500	250	\$19.99
	Hang tag	EXECPLAIN	250	\$19.99
C	Hang tag	NECBRO	100	\$8.35
D	Golden elastic	EXECMEL6G	100	\$6.50

SIGNS AND FLAGS



	DESCRIPTION	PRODUCT CODE	PRICE
A	9" x 13" cardboard sign	ECMS0913	\$4.75
B	24" x 36" metal sign	ECMS2436	\$65.00
	10" X 14" plastic sign	ECMP1014	\$19.95
	24" X 36" plastic sign	ECMP2436	\$55.00
C	20" x 30" plastic sign	SIGNGR	\$18.95
D	18" x 24" coroplast sign	SIGNYE	\$18.95
E	20" x 30"	SIGNAM	\$18.95
F	20" x 30" plastic sign	SIGNBL	\$18.95
G	Flag	663660	\$39.95

BOTTLES AND PACKAGING

WOODEN STICKS

	Medium wooden sticks pkg 12 668911	\$14.95
	18" wooden sticks 66891	\$13.60
	6" taffy sticks pkg 500 72925050	\$11.15

GLUCOSE AND POWDER GENUGEL

	2,25 kg For the hardness of sweets and lollipops 6680801	\$11.95
	25 kg For the hardness of sweets and lollipops 66808	\$84.95
	200 g For the hardness of sweets and lollipops 72926170	\$19.95

CANDY BOXES

	12 cavities, 4½" X 6" 60115	\$0.58
	25 cavities, 4½" X 9" 60128	\$0.66
	One bite candy box 60101	\$0.32
	1" brown paper cups pkg 1 000 EXBB0251	\$6.75

CONES, BOXES AND SUPPORTS

	72/box 66137	\$5.00
	900/box 66138	\$29.75
	6 holes ECBCOR06	\$0.75
	12 holes ECBCOR12	\$0.80
	CDL wooden support for cones 14 holes 666314	\$26.95

MAPLE TEA

	Tea ECMAPTU	\$5.50
	Herbal tea ECMAPTI	\$5.50

	6 cavity box, 3 ½" X 4 5/8" 60127	\$0.95
	15 cavity box, 7" X 4" X 1" 60131	\$0.95
	Two bite candy box 60102	\$0.42
	1¾" white paper cups pkg 1 000 EXBB0101	\$9.25

BOTTLES AND PACKAGING

HARD CANDY MOLDS

DESCRIPTION	CAVITY/QTY	PRODUCT CODE	PRICE
Assorted designs	20	ECMS3057	\$4.30
Christmas trees	20	ECMSH196	\$4.30
Flowers, fruits, nuts	25	ECMSH479	\$4.30
Small hearts	18	ECMS0204	\$4.30
Maple leaves	12	ECMS3185	\$4.30
Rectangles	20	ECMS3029	\$4.30
Stars	20	ECMSH227	\$4.30
Strawberries	12	ECMSH150	\$4.30



RUBBER CANDY MOLDS



DESCRIPTION	CAVITY/QTY	PRODUCT CODE	PRICE
Christmas trees	20	ECMC1148	\$25.95
Snowmen	20	ECMC1473	\$25.95
Sugar shacks	14	ECMC1165	\$25.95
Cats	40	ECMC1382	\$25.95
Bells	160	ECMC1401	\$91.05
Double hearts	50	ECMC0F42	\$25.95
Small hearts	42	ECMC0119	\$25.95
Big hearts	15	ECMC1056	\$25.95
Stars	20	ECMC1151	\$25.95
Ghosts	20	ECMC1516	\$25.95
Maple leaves	20	ECMC1243	\$25.95
Maple leaves	160	ECMC1301	\$91.05
Maple leaves	240	ECMC1292	\$91.05
Maple leaves	72	ECMC1204	\$91.05
Maple leaves	12	ECMC1138	\$25.95
Maple leaves	8	ECMC1137	\$25.95
Fleurs-de-lis	20	ECMC1270	\$25.95
Snow flakes	20	ECMC1477	\$25.95
Fruits and flowers	105	ECMC0011	\$91.05
Mixed fruits	77	ECMCA041	\$91.05

DESCRIPTION	CAVITY/QTY	PRODUCT CODE	PRICE
Owls	16	ECMC1480	\$25.95
Rabbits	36	ECMC1384	\$91.05
Rabbits	160	ECMC1360	\$91.05
Small rabbits	7	ECMC1136	\$25.95
Big rabbits	4	ECMC1135	\$25.95
Daisies	63	ECMC0069	\$25.95
Assorted designs	160	ECMC0830	\$91.05
Assorted Christmas	80	ECMC1451	\$91.05
Moose	6	ECMC0006	\$25.95
Butterflies	20	ECMC1483	\$25.95
Santa Clauses	10	ECMC1133	\$25.95
Santa Clauses	20	ECMC1150	\$25.95
Small women	80	ECMC1233A	\$91.05
Small mermaids	20	ECMC1233	\$25.95
Small men	80	ECMC1162	\$91.05
Small bears	12	ECMC1398A	\$25.95
Chicken	160	ECMC1159	\$91.05
Wooden buckets	16	ECMC1236	\$25.95
Indian heads	6	ECMC1176	\$25.95

CHOCOLATE MOLDS



DESCRIPTION	CAVITY/QT	PRODUCT CODE	PRICE
Squares	20	EMCC071	\$4.75
Maple leaves	12	EMCC0121	\$4.75
Fleurs-de-lis (squares)	12	EMCC079	\$4.75
Snow flakes	9	EMCC039	\$4.75
Assorted designs	12	EMCC055	\$4.75
Ovals	12	EMCC035	\$4.75
Pyramids	12	EMCC129	\$4.75
Rounds	12	EMCC070	\$4.75
Farm animals <small>(for suckers)</small>	4	EMCS11219	\$4.75
Cow <small>(for suckers)</small>	5	ECMS3624	\$4.75

SUCKER BAGS AND STICKS



DESCRIPTION	DIMENSIONS	QTY/PKG	PRODUCT CODE	PRICE/PKG
Cellophane bags	4¾" x 6¾"	100	ECMSC406	\$6.75
Cellophane bags	3" x 4"	100	ECMSC304	\$3.95
Plastic bags	3" x 5"	100	ECMSS305	\$2.25
Plastic bags	4" x 5"	100	ECMSS405	\$2.50
Sticks	3¾"	1000	ECMSB375	\$16.95
Sticks	4½"	1000	ECMSB450	\$19.25

SUCKER CANDY MOLDS



DESCRIPTION	CAVITY/QT	PRODUCT CODE	PRICE
Barrels	7	ECMS3205	\$4.30
Baseballs	6	ECMS3043	\$4.30
Snowmen	6	ECMSH404	\$4.30
Hearts	6	ECMSH324	\$4.30
Elephants	5	ECMS0572	\$4.30
Maple leaves	6	ECMS3450	\$4.30
Frogs	5	ECMS3303	\$4.30
Rabbits (female)	5	ECMSH254	\$4.30
Daisies	3	ECMS0866	\$4.30
Skates	4	ECMS6250	\$4.30
Apples	6	ECMS3190	\$4.30
Rounds	3	ECMS0573	\$4.30
Smiles (big)	4	ECMSH962	\$4.30
Smiles (small)	6	ECMSH961	\$4.30
Santa Claus heads	6	ECMSG214	\$4.30
Tractors	4	ECMS1219	\$4.30

DISPENSER



Tape dispenser
661150 \$19.25



9 mm x 165 m
tape
661151 \$5.50



9 mm x 165 m
red tape
661153 \$5.50



BOOKS



The Maple Syrup Book

A book that celebrates the human aspect of maple syrup production from yesterday to today.

TMSB00 \$24.95



A Guide To Improving and Maintaining Sugar Bush Health and Productivity

This book provides guidelines that help maple producers improve and maintain the productivity of their sugar bush.

BOOSBH \$24.95



Design, Installation and Maintenance of Plastic Tubing Systems for Sap Collection in Sugar Bushes

This manual includes detailed information on the design, installation and maintenance of sap collection systems.

BOODIM \$19.95



Bigleaf Sugaring, Tapping the Western Maple

A practical guide to bottling in order to obtain a quality product.

BIGSUG \$16.95



The Birch Syrup Production Manual

An informative manual for those interested in the production of birch syrup.

BIRMAN \$43.35



Backyard Sugarin'

An excellent guide for people who would like to start producing maple syrup for pleasure or personal enrichment.

ECBYSMAN4 \$14.15



Maple Sugar

ECMAPLE \$14.95



The Sugarmaker's Companion

This guide is the first of its kind, addressing the small and big syrup producer who is looking to have a profitable business out of maple, birch and nut sap.

SUGCOM \$47.60



Farmstead Favorites: Maple Syrup Cookbook

Over 75 proposed recipes made from fresh farm produce.

FARFAV \$10.50



The Maple Syrup Cookbook

Offers recipes for breakfasts, appetizers, beverages, pastries and desserts.

ECCBOOK2 \$14.95



Vermont Cookbook

Cookbook.

ECCBOOKVT \$19.90



DVD "The Sweetest Drip" Making of Maple Syrup

Maple syrup making DVD.

ECDVD01 \$34.95



Sugarhouse Coloring Book

Coloring book.

ECSUGCOLOR \$1.60



A Day At The Sugarbush

Book includes colorful images and simple texts for young readers. Ideal for children from 4 to 8 years old.

DAYSUG \$7.95



At Grandpa's Sugar Bush

Illustrated history book on the making of maple syrup and annual traditions. For children from 3 to 8 years.

(Limited quantity)

SUGBSC \$6.95



The Sugaring-Off Party

A French Canadian grandmother remembers her first sugar party, music, dance and lots of food. For children from 4 to 8 years old.

SUGOSC \$10.95



CORPORATE STORES AND REPRESENTATIVES

UNITED-STATES

The CDL experience translates into personalized service at each stage of your maple sap processing. Just like a family, our maple experts make suggestions and guide you so that the quality of your harvest meets your expectations and those of your consumers here and abroad.



CORPORATE STORES

CDL St. Albans

3 Lemnah Drive
St. Albans, VT 05478
P. 802-527-0000 F. 802-524-3666
Toll free. 800-762-5587
stalbans@cdlusa.net
www.cdlusa.com

CDL Morrisville

559 Harrel Street
Morrisville, VT 05661
P. 802-851-8232 F. 802-851-8153
morrisville@cdlusa.net

CDL Northeast Kingdom

The Pick N' Shovel
54 Conventry Street
Newport, VT 05855
P. 802-334-8370 F. 802-334-1218
pick.maple@comcast.net

CDL Western New York

5704 State Route 19A
Castile, NY 14427
P. 585-493-5102 F. 585-493-5105
wny@cdlusa.net

CDL Pennsylvania

91 Patterson Road
Westfield, PA 16950
P. 814-628-2082 F. 814-628-2084
Toll free 1-855-501-2771
pai@cdlusa.net

CDL Southern Pennsylvania

246 Sugar Cake Road
Somerset, PA 15501
c. 814 442-3680
spa@cdlusa.net

CDL Ohio Richards Maple Products

545 Water Street
Chardon, OH 44024
P. 440-286-4160 c. 330-206-1606
ohio@cdlusa.net

CDL Wisconsin

Peter & Dawn Roth
Roth Sugar Bush
656 Tower Drive
Cadott, WI 54727
P. 715-289-3820 F. 715-289-3821
info@rothsugarbush.com
www.rothsugarbush

CDL Michigan RMG Family Sugar Bush

11866 West Thompson Road
Rudyard, MI 49780
P. 906-478-3038 F. 906-478-7830
Toll free 1-800-50MAPLE (506-2753)
c. 906-322-0765
mjross@lighthouse.net
www.rmgmaple.com

CDL Rutland

1867 US-7
Pittsford, VT 05763
P. 802-725-8040 F. 802-725-8097
rutland@cdlusa.net

CDL Maine

319 US Route 2E
Wilton, ME 04294
P. 207-645-4000 F. 207-645-4003
maine@cdlusa.net

CDL Enosburg

257 Pearl Street
Enosburg Falls, VT 05450
P. 802-933-4279 F. 802-933-6908
enosburg@cdlusa.net

CDL North East NY

1036 Slosson Road
West Chazy, NY 12992
P. 518-493-3043 F. 518-493-2153
neny@cdlusa.net

CDL Lancaster

393 Main Street
Lancaster, NH 03584
P. 603-788-2600 F. 603-788-3998
lancaster@cdlusa.net

REPRESENTATIVES

Nick Atherton

Franklin County, VT
c. 802-309-9610

Zel Larivee

Franklin County, VT
P. 802-933-4279

Mitchell Charron

In House ST. Albans, VT
c. 802-393-9092

Rick Marsh

Lamoile, Chittenden and
Washington Counties, VT
c. 802-730-4604

Larrs Hardy

Lamoile, Chittenden and
Washington Counties, VT
c. 802-782-5633

Keith Wakefield

In house, Morrisville store, VT
c. 802-782-2597

Tom Patterson

ME, RI, MA, CT, NH
c. 802-782-2450

David Allen

Southern Chittenden and
Western Addison Counties, VT
c. 802-734-1105

Ben Shepard

Orange, SO. Washington, SE Addison,
SO. Caledonia Counties, VT
c. 802-373-2799

Reg Charbonneau

Southern VT
c. 802-236-3452

Miguel Ibarguen

Maine
c. 207-578-0411

Tim Bockus

New York
c. 802-309-8847

Mike Parker

North East NY
c. 518-420-4497

Gordy Putnam

Western NY
c. 585-322-5507

Scott Boyce

Northeast Kingdom VT
c. 802-782-6150

Tim Eldridge

Northern PA
c. 814-367-7811

Mike Lynch

Southern PA, IN, WV, OH, IL
c. 814-442-3680

Fred Ahrens

Ohio
c. 330-206-1606

James Adamski

WI, IA, MI
c. 715-216-7855

Doug and Debra DeGrave

Lee Wood, Bark River, MI
South western Upper peninsula
c. 906-723-3723



DISTRIBUTORS UNITED STATES

ALASKA

Alaska Wild Harvest

Mike and Dulce East
Dba Kahiltna Birchworks
5400 E Revolutionary Way
Wasilla, AK 99654
P. 907-373-1309 F. 907-373-1359
www.alaskabirchsyrup.com
michael@alaskabirchsyrup.com

CONNECTICUT

Lamothe's Sugar House

Robert & Jean Lamothe
89 Stone Road
Burlington, CT 06013
P. 860-675-5043
www.lamothesugarhouse.com
lamothesugarhouse@gmail.com

INDIANA

Sweet Beginnings Maple

Silas Beachler
9569 South 600 East
Claypool, IN 46510
P. 260-578-1625
silasjay90@yahoo.com

MAINE

Slattery's Farm & Maple Supply Co.

Wayne & Joni Slattery
1381 Woodman Hill Road P.O. Box 94
West Minot, ME 04288
P. 207-966-3643
slatbake2001@yahoo.com

Lyle & Jo Ann Merrifield

195 North Gorham Road
Gorham, ME 04038
P. 207-892-5061 C. 207-415-3001
merfarm@aol.com

MASSACHUSETTS

Dufresne's Sugarhouse

Keith Dufresne
113 Goshen Road
Williamsburg, MA 01096
P. 413-268-7509 C. 413-559-7072
sugarmaker@msn.com

QSH Maple Supplies

Michael Quinn
78 Main Street
North Field, MA 01360
P. 413-834-5083
mquinn28@yahoo.com

Ioka Valley Farm

Rob & Missy Leab
3475 Hancock Road
Hancock, MA 01237
C. 413-441-5147
missy@iokavalleyfarm.com

MINNESOTA

Don's Sugar Shack

Don Hanson
842 West Street
Taylors Falls, MN 55084
P. 612-201-1086
don@tfmaple.com

Timber's Sugar Shack

Tim and Amber Woodrow
1037 1st Street NW
Aitkin, MN 56431
P. 218-429-5805
C. 218-831-6799
timberssugarshack@gmail.com

NEW HAMPSHIRE

Bascom Maple Farms, Inc.

56 Sugarhouse Road
Alstead, NH 03602
P. 603-835-6361 F. 603-835-2455
sales@bascommapple.com

D & D Maple Supplies

Dave Kemp
5 Sawmill Drive, unit 8
Jaffrey, NH 03452
P. 603-532-8496 C. 603-562-6973
Scott Kemp C. 603-801-4690
david.kemp7@myfairpoint.net

Hicks Hardware

120 Main Street
Colebrook, NH 03576
P. 603-237-5531 F. 603-237-4190

Sunnyside Maples, Inc.

Mike Moore
130 Asby Road
Canterbury, NH 03224
P. 603-783-9961
C. 603-848-7091 F. 603-267-6457
sugarmaker@aol.com

NEW YORK

Dominic's Hardware and Supplies, Inc.

Jim Dominic
5195 State Route 11
Ellenburg Depot, NY 12935
P. 518-594-3922 F. 518-594-7786
lynn@dominicshardware.com

Grottoli's Maple Farm

91 Ritchie Road
Middle Granville, NY 12849
P. 518-642-2856 C. 518-796-8469
grottolimapple@yahoo.com

Catskill Mountain Maple

Thomas Kaufman
65 Charlie Wood Road
DeLancey, NY 13752
P. 607-746-6215 F. 607-746-8367
tomshane95@msn.com

Moser's Maple Ridge Farm

Lyndon Moser
3981 Wilson Road
Copenhagen, NY 13626
P. 315-688-2518 C. 315-486-3248
mosersmapleridgefarm@gmail.com

Mill Creek Maple Supply

David Norton
1551 County Highway 20
Edmeston, NY 13335
P. 607-965-6920 F. 607-965-6921
millcreekmaple@yahoo.com

Mike Bennett

82 Mc Donald Street
Glens Falls, NY 12801
P. 518-222-4990
tapholemaple@gmail.com

Dick Dunn

373 Hunt Hill Road,
Ithaca, NY 14850
P. 607-539-6515 C. 607-342-1452
dpdunn@gmail.com

Woody's Maple Supplies

James Woodrow
418 Underwood Road
Hermon, NY 13652
P. 315-347-2395 Jim 315-783-8148
Josh 315-528-3080
jjaw@tds.net

Maple Glen Sugarhouse

Paul Lesesfske
2266 Gowanda Zoar Road
Gowanda, NY 14070
P. 716-532-5483
pl2266@yahoo.com

Himrod Farm Supplies

3141 Himrod Road
Himrod, NY 14842
P. 315-531-9497 F. 315-531-9498

Sweet Ridge Maple Farm

Dan Weed
1539 West Danby Road
Newfield, NY 14876
P. 607-564-4027 C. 315-567-9900
danweed@yahoo.com

OHIO

Gortner's Maple

1244, Township Road 13
West Salem, OH 44287
P. 419-869-7353 C. 419-651-2425
rdgortner@frontier.com

Williams Maple Products

Joshua Williams
Canal Winchester
OH 43110
P. 614-920-1935 C. 419-239-6764
williammapleproducts@gmail.com

PENNSYLVANIA

Brenneman's Maple Farm

Iddo Brenneman
572 Oak Dale Road
Satisbury, PA 15558
P. 814-662-2010

Loch's Maple

Randy & Jamie Loch
143 Cokely Road
Springville, PA 18844
P. 570-965-2679 C. 570-240-1432
www.lochsmapple.com
maple4u@epix.net

Triple Creek Maple LLC

Gary Bilek
9225 Fillinger Road
Cranesville, PA 16410
P. 814-756-4500
triplecreekmaple@yahoo.com

VERMONT

Rogers Hill Sugar Maple Farm

Steve Rogers
88 Upper Rogers Road
Bradford, VT 05033
P. 802-431-8733
rtbusing@wavecomm.com

WEST VIRGINIA

Daniels Maple Products

Brandon Daniels
1747 Morris Branch Road
Dawson, WV 25976
P. 304-252-7770 C. 304-575-7266
wvmapler@suddenlink.net

WISCONSIN

Adamski's Sugar Bush

James Adamski
W10923 Winter Road
Antigo, WI 54409
P. 715-623-6853 C. 715-216-7855
cdladamski@gmail.com

Morley's Maple Syrup

John and Crystal Morley
141 West 1st Avenue
Luck, WI 54853
P. 715-554-2301
john@morleymaplesyrup.com

Horner's Corner

Steve Horner
1240th Avenue
Boyceville, WI 54725
P. 715-643-3711

Sugar Grove Maple Supply

Emmanuel and Owen Hershberger
S2030 County Road D
Westby, WI 54667
P. 608-625-6745

Russ Schneveis

737 Naugart Drive
Athens, WI 54411
P. 715-257-7713

Roger Bundy

N402 County Road D
Eau Galle, WI 54737
P. 715-495-0872

CORPORATE STORES, DISTRIBUTORS AND REPRESENTATIVES

ONTARIO AND NEW-BRUNSWICK

ONTARIO

CORPORATE STORES

CDL Central Ontario

2907, Highway 11 N
Oro-Medonte (ON) L0L 2E0
P. 705-487-3331 F. 705-487-0460
Toll free 1-800-959-9192
atkinson@cdlinc.ca

CDL Eastern

3464 Station Street
Monkland (ON) K0C 1V0
P. 613-346-0333 F. 613-346-1333
eastern@cdlinc.ca

CDL Western

3301 Perth Road 180, RR#2
Staffa (ON) N0K 1Y0
P. 519-345-0259 F. 519-345-0350
western@cdlinc.ca

CDL Lanark County

38 Dufferin Street
Perth (ON) K7H 3A4
P. 613-259-5554 F. 613-259-2409
lanark@cdlinc.ca

DISTRIBUTORS

RMG Family Sugar Bush

11866 W. Thompson Road
Rudyard, MI 49780
P. 906-478-3038 F. 906-478-7830
c. 906-322-0765
mjross@lighthouse.net

Kentvale Home Hardware

712, K-line Road
Richards Landing, On P0R 1J0
P. 705-246-2002 F. 705-246-2361
kentvale.merchants@gmail.com

Northway Home Hardware

Maple Syrup Supplies
4231 Perth Road
Inverary, On K0H 1X0
P. 613-353-7000 P2. 613-353-2155
northway@kingston.net

REPRESENTATIVES

George Roney

Brant, Bruce, Chatam-Kent, Dufferin, Elgin, Essex,
Haldiman, Hamilton, Huron, Lambton Middlesex,
Niagara, Norfolk, Oxford, Perth, Waterloo, West Grey, West
Willington Peel
george.roney@cdlinc.ca
c. 519-949-1954

CDL Central Ontario

Durham, East Grey, East Willington Peel, Halton,
Kawartha Lakes, Muskoka, Northumberland,
Peterborough, Simcoe, South Haliburton, Toronto,
West Parry sound, York
P. 705-487-3331

Steve Skinner

Frontenac, Grenville, Hasting, Lanark, Lennox & Addington,
Leeds, Ottawa, Prince Edward, Renfrew
steve.skinner@cdlinc.ca
c. 613-299-7874

Yan Gaudet

Cochrane, East Parry Sound, Manitoulin, Nipissing,
North Haliburton, Sudbury, Timiskaming
yan.gaudet@cdlinc.ca
c. 819-629-4157

Rob Berkvens

Glengarry, Prescott & Russell, Stormont Dundas
rob.berkvens@cdlinc.ca
c. 613-551-3333 P. 613-346-0333

NEW-BRUNSWICK

CORPORATE STORES

CDL St-Quentin

7, rue Canada
Saint-Quentin (NB) E8A 1J2
P. 506-235-9100 F. 506-235-2894
stquentin@cdlinc.ca

CDL Acadie

1873, rue Bellechasse, Paquetville, (NB) E8R 1M9
P. 506-764-3280 F. 506-727-8699
acadie@cdlinc.ca

REPRESENTATIVES

Marc Chiasson

Acadie
marc.chiasson@cdlinc.ca
c. 506-727-8699

Michaël Boucher

New-Brunswick (North)
michael.boucher@cdlinc.ca
c. 418-313-3775

Jacques St-Pierre

New-Brunswick (North-West)
jacques.st-pierre@cdlinc.ca
c. 418-860-7447



CORPORATE STORES AND DISTRIBUTORS

QUEBEC

QUEBEC CORPORATE STORES

Les Équipements d'érablière CDL inc.

257, route 279
Saint-Lazare (QC) G0R 3J0
P. 418-883-5158 F. 418-883-4159
Toll free 1-800-361-5158
st-lazare@cdlinc.ca

CDL Cabano

315, boulevard Industriel
Témiscouata-sur-le-Lac (QC) G0L 1E0
P. 418-854-5158 F. 418-854-1118
Toll free 1-877-854-5158
cabano@cdlinc.ca

CDL Haut-St-Laurent

2535, Route 209
Saint-Antoine-Abbé (QC) J0S 1N0
P. 1-844-805-1235 F. 1-844-805-1675
hautst-laurent@cdlinc.ca

CDL La Guadeloupe

295, 14^e Avenue
La Guadeloupe (QC) G0M 1G0
P. 418-459-6218 F. 418-459-3210
Toll free 1-800-459-6218
beauce@cdlinc.ca

CDL L'Islet

194, route 204
Saint-Adalbert (QC) G0R 2M0
P. 418-356-5153
lislet@cdlinc.ca

CDL Lourdes

282 Route 265
Notre-Dame-de-Lourdes (QC) G0S 1T0
P. 819-245-0058 F. 819-245-0059
lourdes@cdlinc.ca

CDL Mégantic

2294 Rue Laval
Nantes (QC) G6B 2V5
P. 819-554-8443
megantic@cdlinc.ca

CDL Mont-Laurier

1054, boulevard Albiny-Paquette
Mont-Laurier (QC) J9L 1M1
P. 873-388-0145
mont-laurier@cdlinc.ca

CDL Portneuf

1142, avenue St-Louis
Portneuf (QC) G0A 2Y0
P. 418-286-0003 F. 418-286-0151
portneuf@cdlinc.ca

CDL Roxton Falls

286, rue Notre-Dame
Roxton Falls (QC) J0H 1E0
P. 450-548-2242 F. 450-548-2481
roxtonfalls@cdlinc.ca

CDL Sainte-Auréli

Équipements d'érablière Guy Maheux inc.

8, rang Saint-Jean-Baptiste
Sainte-Auréli (QC) G0M 1M0
P. 418-593-3804 P. 418-593-3805
F. 418-593-3804
ste-aurelie@cdlinc.ca

CDL Sainte-Marie

1235, rue 2 du Parc Industriel
Sainte-Marie (QC) G6E 1G7
P. 418-387-2215
sainte-marie@cdlinc.ca

CDL Sawyerville

143, rue de Cookshire
Sawyerville (QC) J0B 3A0
P. 819-416-1505 F. 819-416-1501
sawyerville@cdlinc.ca

CDL Shefford

2981, route 112
Shefford (QC) J2M 1C6
P. 450-539-2225 F. 450-539-0500
shefford@cdlinc.ca

CDL Thetford

1892, rue Nadeau, Thetford Mines
Secteur Pontbriand (QC) G6H 3K3
P. 418-335-0853 F. 418-335-3745
thetford@cdlinc.ca

CDL Warwick

1, route 116 Est
Warwick (QC) J0A 1M0
P. 819-358-3950 F. 819-358-3959
warwick@cdlinc.ca

DISTRIBUTORS

01- BAS-SAINT-LAURENT

Magasin Général L.G. Thibault

Bas-Saint-Laurent (Ouest)
6123, de l'Église
Saint-Athanase (QC) G0L 2L0
P. 418-859-2171 F. 418-859-3045

14-LANAUDIÈRE

Agri-Service D.M.R. inc.

Lanaudière
4011, rue Principale
Saint-Félix-de-Valois (QC) J0K 2M0
P. 450-889-8341 F. 450-889-2305
Toll free. 1-800-667-7030

15-LAURENTIDES

Meuneries Mondou

Laurentides
12429, route Arthur-Sauvé
Mirabel (QC) J7N 2C2
P. 450-258-2817 F. 450-258-4626
Toll free. 1-888-258-2817
groupemondou@meuneriemondou.com

Les Moulins B.G.L. inc.

Laurentides
14, rue Legault
St-André-d'Argenteuil (QC) J0V 1X0
P. 450-537-3774 F. 450-537-3777



**ROTH SUGAR BUSH
MAPLE EQUIPMENT**

ROTH SUGAR BUSH

Maple Sugaring Equipment & Pure Maple Syrup

Your Land! Your Brand! Run with the Best!

Roth's Pan Cleaner & Spouts



Royal Cast Aluminum Spouts (each)..... \$ 1.95
Pan Cleaner (1 gallon) \$17.00
4 gallons or more (per gallon) \$16.50



Sap & Syrup Testing Instruments



Sap Hydrometer \$16.00
Syrup Hydrometer \$16.00
Stainless Steel Hydrometer Cup \$22.00



Sugar Hill Jugs Minnesota Family Traditions



Gallon \$2.36 ea. - 24 per case \$ 56.64
1/2 Gallon \$1.79 ea. - 32 per case \$ 57.28
Quarts \$1.37 ea. - 96 per case \$131.52
Pints \$1.19 ea. - 100 per case \$119.00
1/2 Pints \$1.09 ea. - 100 per case \$109.00
3.4 oz. \$.97 ea. - 100 per case \$ 97.00



Sugar Hill Sweet Gold Jugs Wisconsin or Minnesota



Gallon \$2.36 ea. - 24 per case \$ 56.64
1/2 Gallon \$1.79 ea. - 32 per case \$ 57.28
Quarts \$1.37 ea. - 96 per case \$131.52
Pints \$1.19 ea. - 100 per case \$119.00
1/2 Pints \$1.09 ea. - 100 per case \$109.00
3.4 oz. \$.97 ea. - 100 per case \$ 97.00



Glass Containers



Quarts per dozen \$13.50
Pints per dozen \$ 9.50
3/4 Pints (with handles) per dozen \$ 9.95
1/2 Pints (with handles) per dozen \$ 9.95
16 oz. Plastic Bottles per dozen \$ 8.50
Extra Caps each \$.25

Note: These include the white flip top caps



Blue or Clear Sap Saks



Individual each \$.27
250 or more each \$.25



Wisconsin Grade A Labels



1,000 per roll \$ 11.00



Pure Maple Syrup Labels



3" x 3-1/8"..... 100 per roll \$7.50
3" x 2"..... 100 per roll \$7.50

We carry many other labels for fancy glass bottles.
Prices will vary. Please call or check our Website



All prices are F.O.B. Cadott, Wisconsin. We ship U.P.S. daily.

We will fill orders as they are received.
Please allow 3 to 5 days for shipment after your order is received.

www.rothsugarbush.com
715-289-3820



We buy all grades of bulk pure maple syrup, May 1st to January 1st, paying cash when you deliver to our sugarbush.

ROTH SUGAR BUSH - Super Store

Maple Syrup Making Equipment

656 Tower Drive

Cadott, Wisconsin 54727

Phone: 715-289-3820

Fax: 715-289-3821

Website: www.rothsugarbush.com

Email: info@rothsugarbush.com

PRESRT STD
U.S.POSTAGE
PAID
PERMIT NO. 2000
EAU CLAIRE, WI

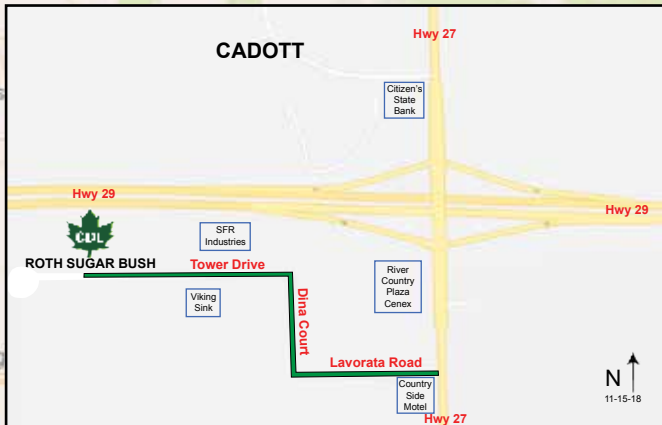

TIM & AMBER WOODROW ★
AITKIN, MN
218-429-5805

JOHN & CRYSTAL MORLEY ★
LUCK, WI
715-554-2301

DON HANSON ★
TAYLORS FALLS, MN
612-201-1086

STEVE HORNER ★
BOYCEVILLE, WI
715-643-3711

ROGER & TONY BUNDY ★
EAU GALLE, WI
715-495-0872

EMANUEL & OWEN HERSHBERGER ★
CASHTON, WI

ROTH SUGAR BUSH
SUPER STORE
CADOTT, WI
715-289-3820

JIM ADAMSKI ★
ANTIGO, WI
715-216-7855

RUSS SCHNEVEIS ★
ATHENS, WI
715-257-7713



ROTH SUGAR BUSH
MAPLE EQUIPMENT



OPEN HOUSE
February 6, 7, 8 & 9, 2019
Cadott, Wisconsin
Complimentary Lunch
Special Discounts
Prizes

Check your Email for our Open House Seminar Schedule